

# 14 CHANNEL COMPUTER SYSTEM 14SG

**S.BUS 2**™

2.4GHz  
**FASSTest**  
Extended System Telemetry™



## INSTRUCTION MANUAL

**Futaba**®

*Digital Proportional R/C System*

CE0682Ⓢ

1M23N27902

14 CHANNEL COMPUTER SYSTEM  
**14SG**

---

**INSTRUCTION MANUAL**

Technical updates and additional programming examples available at: <http://www.futaba-rc.com/faq>  
Entire Contents © 2012

---

# TABLE OF CONTENTS

---

|  |   |
|--|---|
| INTRODUCTION.....  | 4 |
| •Support and Service .....                                 | 4 |
| •Application, Export, and Modification .....               | 5 |
| •Definitions of Symbols.....                               | 6 |
| •Safety Precautions (do not operate without reading) ..... | 6 |

---

|   |    |
|---|----|
| BEFORE USE .....                              | 10 |
| •Features of 14SG .....                       | 10 |
| •Contents and technical specifications .....  | 11 |
| •Accessories.....                             | 12 |
| •Transmitter controls.....                    | 13 |
| Cautions on handling antenna .....            | 14 |
| LED monitor.....                              | 14 |
| Switch (SA-SH).....                           | 15 |
| Digital trim (T1-T4) .....                    | 15 |
| Volume (LD, RD).....                          | 15 |
| Slide Lever (LS, RS).....                     | 15 |
| HOME/EXIT, U.MENU/MON. Button.....            | 15 |
| Touch sensor .....                            | 16 |
| Stick adjustment.....                         | 17 |
| SD card.....                                  | 19 |
| Connector/Plug.....                           | 21 |
| Installation and removal of the battery.....  | 22 |
| •Receiver nomenclature.....                   | 24 |
| •Receiver's antenna installation.....         | 26 |
| •Safety precautions when installing servos... | 27 |
| •S.BUS/S.BUS2 Installation .....              | 28 |
| •S.BUS Wiring example.....                    | 29 |
| •S.BUS2 System.....                           | 30 |
| •S.BUS/S.BUS2 Devicesetting .....             | 31 |
| •Telemetry System.....                        | 32 |

---

|                                     |    |
|-------------------------------------|----|
| BASIC OPERATION .....               | 33 |
| •Battery Charging .....             | 33 |
| How to charge the NiMH Battery..... | 33 |

|  |    |
|--|----|
| •How to turn ON/OFF the transmitter .....  | 34 |
| When turning on .....                      | 34 |
| When turning off.....                      | 34 |
| Low battery alarm and auto shut-down ..... | 34 |
| Warning display at power on .....          | 34 |
| •Registration of the user's name .....     | 34 |
| •Home screen .....                         | 35 |
| User Menu.....                             | 36 |
| •Link procedure (T14SG/R7008SB).....       | 37 |
| •Range testing your R/C system.....        | 39 |

---

|                                      |    |
|--------------------------------------|----|
| RACEIVER AND SERVO INSTALLATION. 40  |    |
| •Receiver and servos connection..... | 40 |
| •Servo connection by model type..... | 41 |

---

|   |    |
|---|----|
| MODEL BASIC SETTING PROCEDURE ... 44          |    |
| •Airplane/glider basic setting procedure..... | 44 |
| •Helicopter basic setting procedure.....      | 46 |

---

|                                |    |
|--------------------------------|----|
| FUNCTIONS OF SYSTEM MENU ..... | 50 |
| Trainer.....                   | 51 |
| Display .....                  | 54 |
| User Name.....                 | 55 |
| Sound.....                     | 56 |
| H/W Setting.....               | 57 |
| Start SEL. ....                | 59 |
| Auto Lock .....                | 62 |
| Information .....              | 63 |
| SBUS Servo .....               | 64 |

---

|                                    |    |
|------------------------------------|----|
| FUNCTIONS OF LINKAGE MENU .....    | 67 |
| (Common Functions)                 |    |
| Linkage Menu functions table ..... | 67 |
| Servo Monitor.....                 | 68 |
| Model Select.....                  | 69 |
| Model Type.....                    | 71 |

|  |     |   |     |
|--|-----|---|-----|
| System .....                           | 73  | Pitch Curve (Air/Glid).....   | 117 |
| Function .....                         | 76  | THR Curve (Air only).....   | 118 |
| Sub-Trim .....                         | 78  | THR Delay (Air only).....   | 119 |
| Servo Reverse .....                    | 79  | AIL Differential (Except 1-AIL) .....   | 120 |
| Fail Safe.....                         | 80  | Flap Setting (2-FLP and up).....  | 121 |
| End Point .....                        | 81  | AIL to Camber FLP (2-AIL+2-FLP and up).....   | 122 |
| Servo Speed .....                      | 82  | AIL to Brake FLP (Glid only, 4-FLP) .....   | 123 |
| Throttle Cut (Air/Heli only) .....     | 83  | AIL to RUD.....   | 124 |
| Idle Down (Air only) .....             | 84  | RUD to AIL.....   | 125 |
| Swash Ring (Heli only) .....           | 85  | Camber Mix (Except 1-AIL) .....   | 127 |
| Swash (Heli only, except H-1).....     | 86  | ELE to Camber (Except 1-AIL).....   | 129 |
| T1-T4 Setting.....                     | 89  | Camber FLP to ELE (2-AIL+1-FLP and up) .....  | 130 |
| Warning.....                           | 90  | Butterfly (Glid only, normal wing 2-AIL and<br>up, flying wing 2-AIL+1FLP and up) ..... | 131 |
| Telemetry.....                         | 91  | Trim Mix (Glid only, 2-AIL and up).....   | 133 |
| Telemetry:Rx-batt .....                | 92  | Airbrake (Air only, 2-AIL and up) .....   | 135 |
| Telemetry:Ext-volt .....               | 93  | Gyro (Air only, for GYA type gyro).....   | 137 |
| Telemetry:temp.....                    | 94  | V-tail .....  | 139 |
| Telemetry:rpm.....                     | 95  | Ailevator.....  | 140 |
| Telemetry:altitude .....               | 96  | Winglet (Flying wing only) .....  | 141 |
| Telemetry:vario .....                  | 97  | Motor .....   | 142 |
| Telemetry:battery.....                 | 98  | RUD to ELE (Air only) .....   | 144 |
| Telemetry:distance .....               | 99  | Snap Roll (Air only) .....  | 145 |
| Telemetry:speed.....                   | 101 | • Helicopter Functions .....  | 147 |
| Sensor .....                           | 102 | Model Menu functions list.....  | 147 |
| Sensor:reload .....                    | 103 | PIT Curve/Pit trim.....   | 148 |
| Sensor:register.....                   | 103 | THR Curve/Throttle hover trim/Throttle<br>limiter .....                                 | 151 |
| Sensor:relocate .....                  | 104 | THR Hold.....   | 154 |
| Sensor:set slot .....                  | 104 | Swash Mix.....  | 155 |
| Data Reset .....                       | 105 | THR Mix .....   | 156 |
| <hr/>                                  |     | PIT to RUD (Revolution mix) .....   | 157 |
| <b>FUNCTIONS OF MODEL MENU .....</b>   |     | Gyro (for GY type gyro) .....   | 158 |
| <b>• Common Functions .....</b>        |     | Governor .....  | 161 |
| Servo Monitor (Linkage Menu)           |     | <hr/>   |     |
| Condition Select (Glid/Heli only)..... |     | APPENDIX .....  | 164 |
| Dual Rate .....                        |     | Timer ST1/ST2 .....   | 164 |
| Program Mix.....                       |     | Switch Setting Method.....  | 166 |
| Fuel Mix (Air/Heli only) .....         |     | <hr/>   |     |
| • Airplane/Glider Functions .....      |     |   |     |
| Model Menu functions list.....         |     |   |     |

---

## INTRODUCTION

Thank you for purchasing a Futaba® FASSTest-2.4GHz\* 14SG series digital proportional R/C system. This system is extremely versatile and may be used by beginners and pros alike. In order for you to make the best use of your system and to fly safely, please read this manual carefully. If you have any difficulties while using your system, please consult the manual, our online Frequently Asked Questions (on the web pages referenced below), your hobby dealer, or the Futaba Service Center.

\*FASSTest: Futaba Advanced Spread Spectrum Technology extend system telemetry

Due to unforeseen changes in production procedures, the information contained in this manual is subject to change without notice.

Support and Service: It is recommended to have your Futaba equipment serviced annually during your hobby's "off season" to ensure safe operation.

## IN NORTH AMERICA

Please feel free to contact the Futaba Service Center for assistance in operation, use and programming. Please be sure to regularly visit the 14SG Frequently Asked Questions web site at [www.futaba-rc.com/faq/](http://www.futaba-rc.com/faq/). This page includes extensive programming, use, set up and safety information on the 14SG radio system and is updated regularly. Any technical updates and US manual corrections will be available on this web page. If you do not find the answers to your questions there, please see the end of our F.A.Q. area for information on contacting us via email for the most rapid and convenient response.

Don't have Internet access? Internet access is available at no charge at most public libraries, schools, and other public resources. We find internet support to be a fabulous reference for many modelers as items can be printed and saved for future reference, and can be accessed at any hour of the day, night, weekend or holiday. If you do not wish to access the internet for information, however, don't worry. Our support teams are available Monday through Friday 8-5 Central time to assist you.

### **FOR SERVICE ONLY:**

Futaba Service Center  
3002 N. Apollo Drive, Suite 1  
Champaign, IL 61822  
Phone: 217-398-0007  
[www.futaba-rc.com/service.html](http://www.futaba-rc.com/service.html)  
Email: [service@futaba-rc.com](mailto:service@futaba-rc.com)

### **FOR SUPPORT :**

#### **(PROGRAMMING AND USER QUESTIONS)**

Please start here for answers to most questions:  
[www.futaba-rc.com/faq/](http://www.futaba-rc.com/faq/)  
Fax: 217-398-7721  
Phone: 217-398-8970 option 2

## OUTSIDE NORTH AMERICA

Please contact your Futaba importer in your region of the world to assist you with any questions, problems or service needs.

Please recognize that all information in this manual, and all support availability, is based upon the systems sold in North America only. Products purchased elsewhere may vary. Always contact your region's support center for assistance.

---

## Application, Export, and Modification

1. This product may be used for model airplane or surface (boat, car, robot) use. It is not intended for use in any application other than the control of models for hobby and recreational purposes. The product is subject to regulations of the Ministry of Radio/Telecommunications and is restricted under Japanese law to such purposes.

2. Exportation precautions:

(a) When this product is exported from the country of manufacture, its use is to be approved by the laws governing the country of destination which govern devices that emit radio frequencies. If this product is then re-exported to other countries, it may be subject to restrictions on such export. Prior approval of the appropriate government authorities may be required. If you have purchased this product from an exporter outside your country, and not the authorized Futaba distributor in your country, please contact the seller immediately to determine if such export regulations have been met.

(b) Use of this product with other than models may be restricted by Export and Trade Control Regulations, and an application for export approval must be submitted. This equipment must not be utilized to operate equipment other than radio controlled models.

3. Modification, adjustment, and replacement of parts: Futaba is not responsible for unauthorized modification, adjustment, and replacement of parts on this product. Any such changes may void the warranty.

### Compliance Information Statement (for U.S.A.)

This device, trade name Futaba Corporation of America, model number R7008SB, complies with part 15 of the FCC Rules. Operation is subject to the following two conditions:

- (1) This device may not cause harmful interference, and
- (2) This device must accept any interference received, including interference that may cause undesired operation.

The responsible party of this device compliance is:

Futaba Service Center

3002 N Apollo Drive Suite 1, Champaign, IL 61822 U.S.A.

TEL (217)398-8970 or E-mail: [support@futaba-rc.com](mailto:support@futaba-rc.com) (Support)

TEL (217)398-0007 or E-mail: [service@futaba-rc.com](mailto:service@futaba-rc.com) (Service)



The RBRC. SEAL on the nickel-cadmium battery contained in Futaba products indicates that Futaba Corporation of America is voluntarily participating in an industry-wide program to collect and recycle these batteries at the end of their useful lives, when taken out of service within the United States. The RBRC. program provides a convenient alternative to placing used nickel-cadmium batteries into the trash or municipal waste system, which is illegal in some areas.

(for USA)

You may contact your local recycling center for information on where to return the spent battery. Please call 1-800-8BATTERY for information on NiCd battery recycling in your area. Futaba Corporation of America's involvement in this program is part of its commitment to protecting our environment and conserving natural resources.

\*RBRC is a trademark of the Rechargeable Battery Recycling Corporation.

---

## Federal Communications Commission Interference Statement (for U.S.A.)

This equipment has been tested and found to comply with the limits for a Class B digital device, pursuant to Part 15 of the FCC Rules. These limits are designed to provide reasonable protection against harmful interference in a residential installation.

This equipment generates, uses and can radiate radio frequency energy and, if not installed and used in accordance with the instructions, may cause harmful interference to radio communications. However, there is no guarantee that interference will not occur in a particular installation. If this equipment does cause harmful interference to radio or television reception, which can be determined by turning the equipment off and on, the user is encouraged to try to correct the interference by one or more of the following measures:

- Reorient or relocate the receiving antenna.
- Increase the separation between the equipment and receiver.
- Consult the dealer or your Futaba Service center for help.

### CAUTION:

To assure continued FCC compliance:

Any changes or modifications not expressly approved by the grantee of this device could void the user's authority to operate the equipment.

### Exposure to Radio Frequency Radiation

To comply with FCC RF exposure compliance requirements, a separation distance of at least 20cm must be maintained between the antenna of this device and all persons.

This device must not be co-located or operating in conjunction with any other antenna or transmitter.

### Meaning of Special Markings

Pay special attention to safety where indicated by the following marks:

- ⚠ DANGER** - Procedures which may lead to dangerous conditions and cause death/serious injury if not carried out properly.
- ⚠ WARNING** - Procedures which may lead to a dangerous condition or cause death or serious injury to the user if not carried out properly, or procedures where the probability of superficial injury or physical damage is high.
- ⚠ CAUTION** - Procedures where the possibility of serious injury to the user is small, but there is a danger of injury, or physical damage, if not carried out properly.

⊘ = Prohibited    ⚠ = Mandatory

**Warning:** Always keep electrical components away from small children.

### FLYING SAFETY

#### ⚠ WARNING

To ensure the safety of yourself and others, please observe the following precautions:

- ⚠ Have regular maintenance performed.** Although your 14SG protects the model memories with non-volatile EEPROM memory (which does not require periodic replacement) and not a battery, the transmitter still should have regular checkups for wear and tear. We recommend sending your system to the Futaba Service Center annually during your non-flying-season for a complete checkup and service.

## NiMH/NiCd Battery

- ❗ **Charge the batteries!** (See Charging the NiCd batteries, for details.) Always recharge the transmitter and receiver batteries before each flying session. A low battery will soon die potentially, causing loss of control and a crash. When you begin your flying session, reset your T14SG's built-in timer, and during the session pay attention to the duration of usage.
- ❗ **Stop flying long before your batteries become low on charge. Do not rely on your radio's low battery warning systems, intended only as a precaution, to tell you when to recharge. Always check your transmitter and receiver batteries prior to each flight.**

## Where to Fly

We recommend that you fly at a recognized model airplane flying field. You can find model clubs and fields by asking your nearest hobby dealer, or in the US by contacting the Academy of Model Aeronautics.

You can also contact the national Academy of Model Aeronautics (AMA), which has more than 2,500 chartered clubs across the country. Through any one of them, instructor training programs and insured newcomer training are available. Contact the AMA at the address or toll-free phone number below.

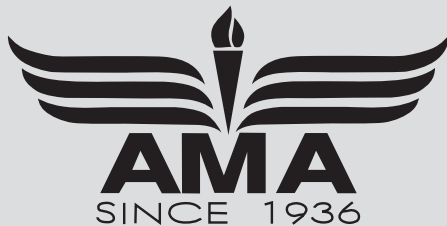

### Academy of Model Aeronautics

5161 East Memorial Drive

Muncie, IN 47302

Tele. (800) 435-9262

Fax (765) 289-4248

or via the Internet at <http://www.modelaircraft.org>

- ❗ **Always pay particular attention to the flying field's rules**, as well as the presence and location of spectators, the wind direction, and any obstacles on the field. Be very careful flying in areas near power lines, tall buildings, or communication facilities as there may be radio interference in their vicinity.



## NiMH/NiCd Battery Safety and Handling instructions

### IMPORTANT!

Use only the **Futaba special charger** included with this set or other chargers approved by Futaba to charge the NiMH batteries in the T14SG transmitter included with this set.

It is important to understand the operating characteristics of NiMH/NiCd batteries. Always read the specifications printed on the label of your NiMH/NiCd battery and charger prior to use. Failure to follow the proceeding precautions can quickly result in severe, permanent damage to the batteries and its surroundings and possibly result in a **FIRE!**

### IMPORTANT PRECAUTIONS

- ⊗ Do not attempt to disassemble NiMH/NiCd packs or cells.
- ⊗ Do not allow NiMH/NiCd cells to come in contact with moisture or water at any time.
- ⚠ Always provide adequate ventilation around NiMH/NiCd batteries during charge, discharge, while in use, and during storage.
- ⊗ Do not leave a NiMH/NiCd battery unattended at any time while being charged or discharged.
- ⊗ Do not attempt to charge NiMH/NiCd batteries with a charger that is NOT designed for NiMH/NiCd batteries, as permanent damage to the battery and charger could result.
- ⚠ Always charge NiMH/NiCd batteries in a fireproof location. Do not charge or discharge NiMH/NiCd batteries on carpet, a cluttered workbench, near paper, plastic, vinyl, leather or wood, or inside an R/C model or full-sized automobile! Monitor the charge area with a smoke or fire alarm.
- ⊗ Do not charge NiMH/NiCd batteries at currents greater than the “1C” rating of the battery (“C” equals the rated capacity of the battery).
- ⊗ Do not allow NiMH/NiCd cells to overheat at any time! Cells which reach greater than 140 degrees Fahrenheit (60°C) should be placed in a fireproof location.
- ⚠ NiMH/NiCd cells will not charge fully when too cold or show full charge.
- ⚠ It is normal for the batteries to become warm during charging, but if the charger or battery becomes excessively hot disconnect the battery from the charger immediately!! Always inspect a battery which has previously overheated for potential damage, and do not re-use if you suspect it has been damaged in any way.
- ⊗ Do not use a NiMH/NiCd battery if you suspect physical damage has occurred to the pack. Carefully inspect the battery for even the smallest of dents, cracks, splits, punctures or damage to the wiring and connectors. DO NOT allow the battery’s internal electrolyte to get into eyes or on skin—wash affected areas immediately if they come in contact with the electrolyte. If in doubt, place the battery in a fire-proof location for at least 30 minutes.
- ⊗ Do not store batteries near an open flame or heater.
- ⊗ Do not discharge NiMH/NiCd batteries at currents which exceed the discharge current rating of the battery.
- ⚠ Always store NiMH/NiCd cells/packs in a secure location away from children.

### Secure Digital (SD) Memory Card Handling Instructions (SD card is not included with this set)

- ⊗ Never remove the SD card or turn off power while entering data.
- ⊗ Never store the SD card where it may be subject to strong static electricity or magnetic fields.
- ⊗ Do not expose the SD card to direct sunlight, excessive humidity or corrosive environments.
- ⊗ Do not expose the SD card to dirt, moisture, water or fluids of any kind.
- ⚠ Always hold the SD card by the edges during installation and removal.
- ⚠ Be certain to insert the SD card in the correct direction.

---

## At the flying field

To prevent possible damage to your radio gear, turn the power switches on and off in the proper sequence:

1. Pull throttle stick to idle position, or otherwise disarm your motor/engine.
2. Turn on the transmitter power and allow your transmitter to reach its home screen.
3. Confirm the proper model memory has been selected.
4. Turn on your receiver power.
5. Test all controls. If a servo operates abnormally, don't attempt to fly until you determine the cause of the problem.  
Test to ensure that the FailSafe settings are correct after adjusting them. Turn the transmitter off and confirm the proper surface/throttle movements. Turn the transmitter back on.
6. Start your engine.
7. Complete a full range check.
8. After flying, bring your throttle stick to idle position, engage any kill switches or otherwise disarm your motor/engine.
9. Turn off receiver power.
10. Turn off transmitter power.

If you do not turn on your system in this order, you may damage your servos or control surfaces, flood your engine, or in the case of electric-powered or gasoline-powered models, the engine may unexpectedly turn on and cause a severe injury.

- ❗ **While you are getting ready to fly, if you place your transmitter on the ground, be sure that the wind won't tip it over. If it is knocked over,** the throttle stick may be accidentally moved, causing the engine to speed up. Also, damage to your transmitter may occur.
- ❗ In order to maintain complete control of your aircraft it is important that **it remains visible at all times**. Flying behind large objects such as buildings, grain bins, etc. is not suggested. Doing so may result in the reduction of the quality of the radio frequency link to the model.
- ⊘ **Do not grasp the transmitter's antenna during flight.** Doing so may degrade the quality of the radio frequency transmission.
- ❗ As with all radio frequency transmissions, the strongest area of signal transmission is from the sides of the transmitter's antenna. As such, the antenna should not be pointed directly at the model. If your flying style creates this situation, easily move the antenna to correct this situation.
- ⊘ **Don't fly in the rain!** Water or moisture may enter the transmitter through the antenna or stick openings and cause erratic operation or loss of control. If you must fly in wet weather during a contest, be sure to cover your transmitter with a plastic bag or waterproof barrier. Never fly if lightning is expected.

---

# BEFORE USE

---

## Features

### FASSTest system

The T14SG transmitter has adopted the newly developed bidirectional communication system "FASSTest". Data from the receiver can be checked in your transmitter. FASSTest is a maximum 14 channels (linear 12 channels + switch 2 channels) 2.4GHz dedicated system.

### S.BUS2 system

By using the S.BUS2 system multiple servos, gyros and telemetry sensors are easily installed with a minimum amount of cables.

### Model types

Six swash types are available for helicopters. Six types of main wings and three types of tail wings are available for airplanes and gliders. Functions and mixing functions necessary for each model type are set in advance at the factory.

### Data input

Large graphic LCD and new type Touch Sensor substantially improve ease of setup.

### Stick

Improved feel, adjustable length and tension.

### Ni-MH battery

T14SG is operated by a 6.0 V/1,800 mAh Nickel-Metal Hydride battery.

### SD card (Secure Digital memory card) (Not included)

Model data can be saved to an SD card (SD:32MB-2GB SDHC:4GB-32GB). When T14SG transmitter software files are released, the software can be updated by using an SD card update.

### Edit button

Two edit buttons are provided, and the operating screen can be immediately "Returned" to the HOME screen during operation. Setting operation can be performed easily by combining this button with a touch sensor.

### Vibration function

Selects a function that alerts the operator to various alarms and timers by vibrating the transmitter in addition to sounding a buzzer.

---

## Contents and Technical Specifications

(Specifications and ratings are subject to change without notice.)

### Your 14SG includes the following components:

- T14SG transmitter for airplanes or helicopters
- R7008SB Receiver
- HT5F1800B NiMH battery & Charger
- Li-Fe spacer for optional FT2F2100B/FT2F1700B LiFe battery pack.
- Switch harness
- Neck strap

\*The set contents depend on the type of set.

### Transmitter T14SG

---

(2-stick, 14-channel, FASSTest-2.4G system)

Transmitting frequency: 2.4GHz band

System: FASSTest14CH, FASSTest12CH, FASST MULT, FASST 7CH, S-FHSS, switchable

Power supply: 6.0V HT5F1800B NiMH battery

### Receiver R7008SB

---

(FASSTest-2.4G system, dual antenna diversity, S.BUS system)

Power requirement: 3.7V~7.4V battery or regulated output from ESC, etc. (\*1)

Size: 0.98 x 1.86 x 0.56 in. (24.9 x 47.3 x 14.3 mm)

Weight: 0.38 oz. (10.9g)

(\*1) When using ESC's make sure that the regulated output capacity meets your usage application.

**Note: The battery in the T14SG transmitter is not connected to the battery connector at initial. Please connect the battery connector before use.**

---

**The following additional accessories are available from your dealer. Refer to a Futaba catalog for more information:**

- HT5F1800B Transmitter battery pack - the (1800mAh) transmitter NiMH battery pack may be easily exchanged with a fresh one to provide enough capacity for extended flying sessions.
- FT2F2100B/FT2F1700B Transmitter LiFe battery pack can also be used by using an exclusive spacer. However, charge with the charger only for LiFe.
- Trainer cord - the optional training cord may be used to help a beginning pilot learn to fly easily by placing the instructor on a separate transmitter. Note that the T14SG transmitter may be connected to another T14SG system, as well as to any other models of Futaba transmitters. The T14SG transmitter uses one of the three cord plug types according to the transmitter connected. (Refer to the description at the TRAINER function instructions). The part number of this cord is: FUTM4405.
- Servos - there are various kinds of servos. Please choose from the servos of Futaba what suited the model and the purpose of using you. If you utilize a S.BUS system, you should choose a S.BUS servo. An analog servo cannot be used if "FASSTest12CH mode" is used.
- Telemetry sensor - please purchase an optional sensor, in order to utilize bidirectional communication system and to acquire the information from a model high up in the sky.  
[Temperature sensor : SBS-01T] [Altitude sensor : SBS-01A] [RPM sensor magnet type : SBS-01RM][RPM sensor optical type : SBS-01RO] [GPS sensor : SBS-01G] [Voltage sensor : SBS-01V]
- Neckstrap - a neckstrap may be connected to your T14SG system to make it easier to handle and improve your flying precision since your hands won't need to support the transmitter's weight.
- Y-harnesses, servo extensions, hub,etc - Genuine Futaba extensions and Y-harnesses, including a heavy-duty version with heavier wire, are available to aid in your larger model and other installations.
- Gyros - a variety of genuine Futaba gyros is available for your aircraft or helicopter needs.
- Governor - for helicopter use. Automatically adjusts throttle servo position to maintain a constant head speed regardless of blade pitch, load, weather, etc.
- Receivers - various models of Futaba receivers may be purchased for use in other models. (Receivers for FASSTest and FASST,S-FHSS types are available.)
- Optional Charger - Futaba CR-2000 NiMH/NiCd Transmitter/Receiver Battery Charger.

## Transmitter controls

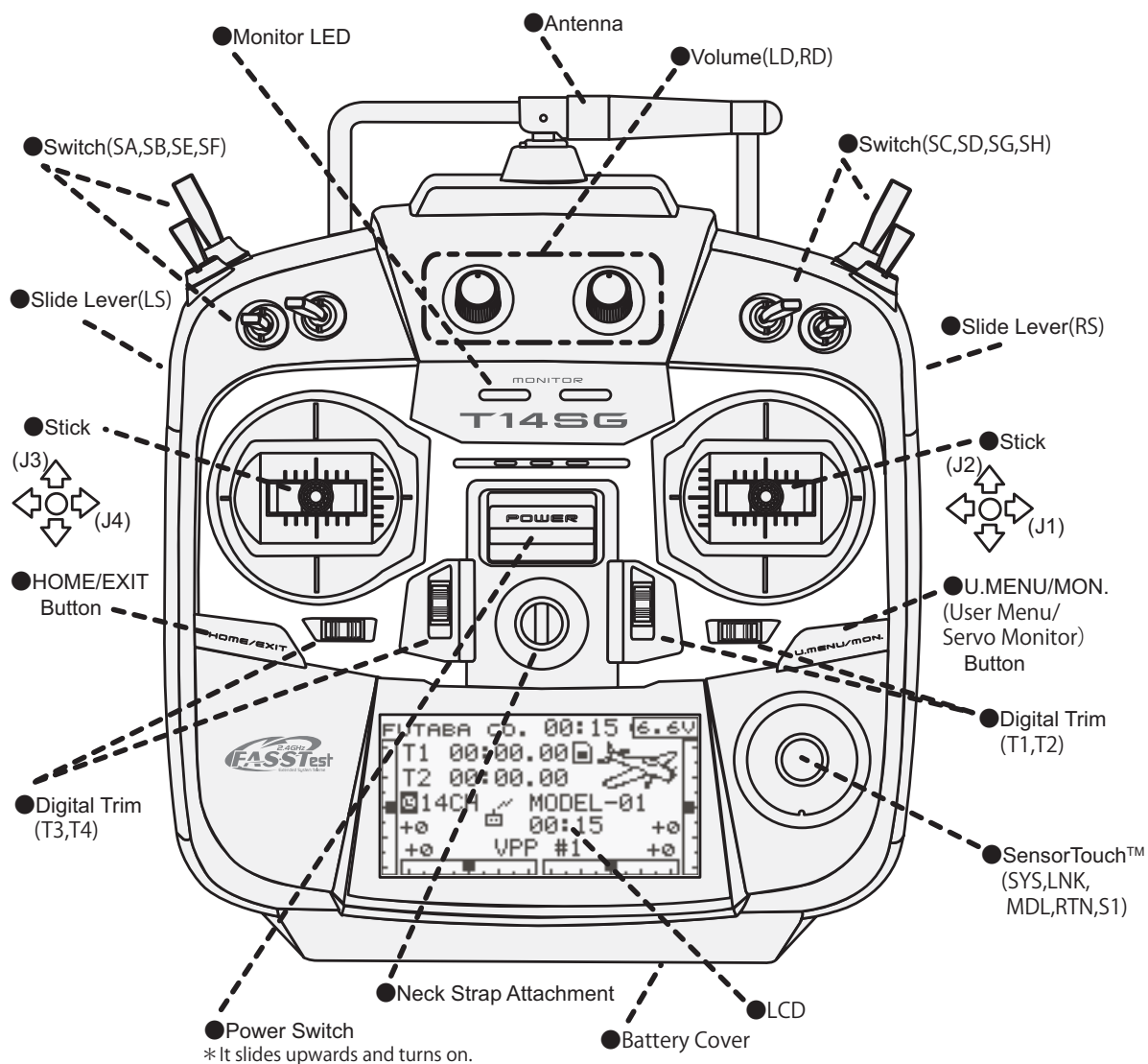

## Transmitter's Antenna:

As with all radio frequency transmissions, the strongest area of signal transmission is from the sides of the transmitter's antenna. As such, the antenna should not be pointed directly at the model. If your flying style creates this situation, easily move the antenna to correct this situation.

### •Rotating antenna

The antenna can be rotated 90 degrees and angled 90 degrees. Forcing the antenna further than this can damage it. The antenna is not removable.

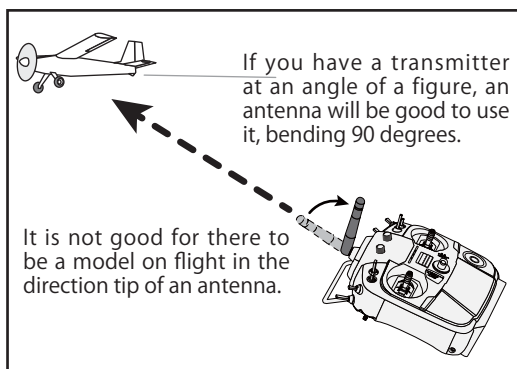
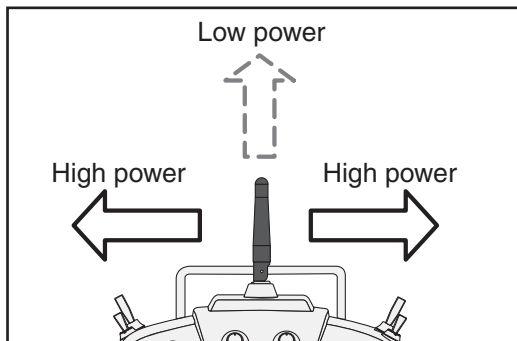
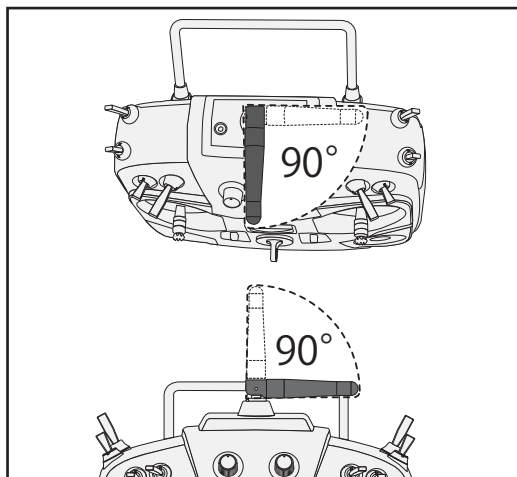

## ⚠ Caution

❗ Please do not grasp the transmitter's antenna during flight.

Doing so may degrade the quality of the RF transmission to the model

⊘ Do not carry the transmitter by the antenna.

There is the danger that the antenna wire will break and operation will become impossible.

⊘ Do not pull the antenna forcefully.

There is the danger that the antenna wire will break and operation will become impossible.

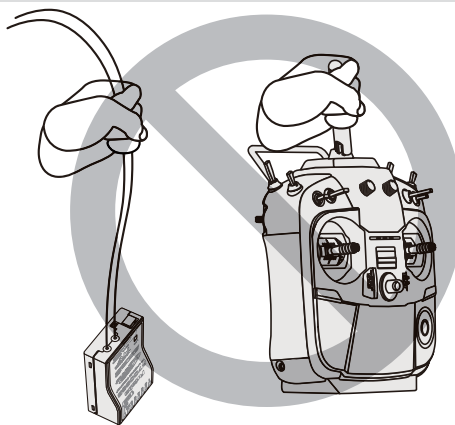

## Monitor LED display

The status of the transmitter is displayed by LED at the bottom left and right sides of the "T14SG" logo.

### LED (Left)

Displays the "non-default condition" warning.

- Blinking  
Power switch is turned on when any condition switch is activated (in the ON state).

### LED (Right)

Displays the state of radio frequency transmission.

- Off  
Radio waves are in the OFF state.
- On  
Radio waves are being transmitted.
- Blinking  
Range check mode.

## Switch (SA-SH)

(Switch Type)

- SA : 3 positions; Alternate; Short lever
- SB : 3 positions; Alternate; Long lever
- SC : 3 positions; Alternate; Long lever
- SD : 3 positions; Alternate; Short lever
- SE : 3 positions; Alternate; Short lever
- SF : 2 positions; Alternate; Long lever
- SG : 3 positions; Alternate; Short lever
- SH : 2 positions; Momentary; Long lever

\*You can choose switch and set the ON/OFF-direction in the setting screen of the mixing functions.

## Digital Trim

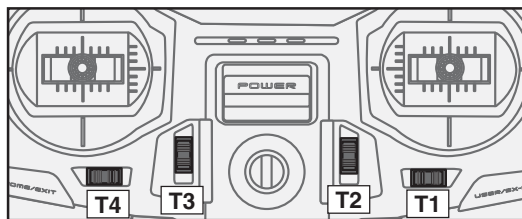

### Digital Trim T1, T2, T3 and T4:

This transmitter is equipped with four (4) digital trims. Each time you press a trim button, the trim position moves one step. If you continue pressing it, the trim position starts to move faster. In addition, when the trim position returns to the center, the tone will change. You can always monitor trim positions by referencing the LCD screen.

\*You can select the trim step amount and the display unit on the home screen on the T1-T4 setting screen within the linkage menu.

Note: The trim positions you have set will be stored in the non-volatile memory and will remain there.

## Volume

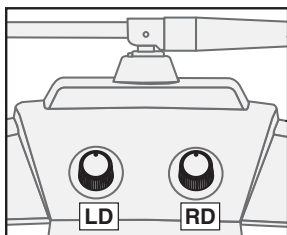

### Volume LD and RD:

The volume LD and RD knobs allow for analog input.

\*The T14SG transmitter beeps when the volume knob reaches the center position.

\*You can use each setting screen of the mixing functions to select volumes and define the direction of a movement.

## Slide Lever

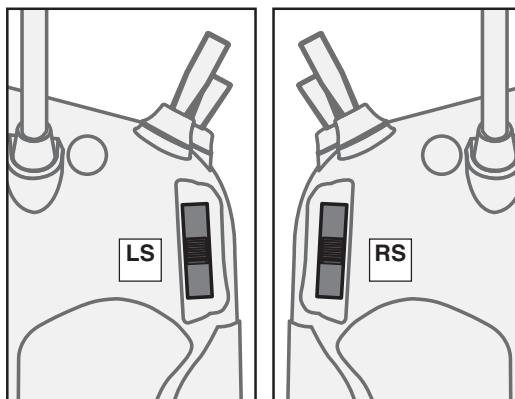

### LS (Left), RS (right):

The slide lever LS and RS offer analog input.

\*The T14SG transmitter beeps when the lever comes to the center.

\*You can select a slide lever and set the movement direction on the setting screen of mixing functions.

## HOME/EXIT and U.MENU/MON. Button

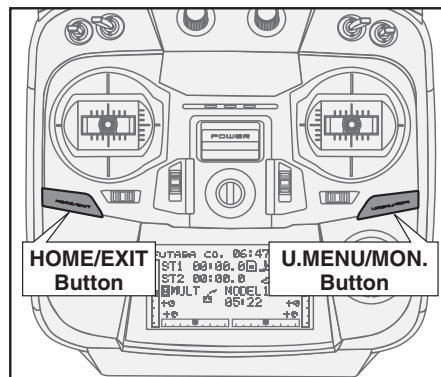

### HOME/EXIT:

|  |                               |
|--|-------------------------------|
| Press  | Return to the previous screen |
| Press and hold                                     | Return to the Home screen     |
| It pushes from HOME screen.                        | To TELEMETRY display          |
| Push and hold for one (1) second from HOME screen. | Key lock On or Off            |





### U.MENU/MON.:

|                |                          |
|----------------|--------------------------|
| Press          | To SERVO MONITOR display |
| Press and hold | To User Menu display     |



## Touch sensor operation

Data input operation is performed using the touch sensor.

| SensorTouch™ operation   | Condition   | Working                                      |
|--|---|--|
| <b>• Short 'tap'</b><br>                        | <b>S1</b><br>If the screen has more than one page. (Ex. P-MIX screen)           | The cursor moves to the top of next page.    |
|  | If the screen have only one (1) page.   | The cursor moves to the top of page.         |
|  | If inputting data while the cursor is blinking.                                 | The input data is canceled.                  |
|  | <b>RTN</b><br>At the moving cursor mode.  | Change to the input data mode.               |
|  | While in the data input mode.   | Changes to the moving cursor mode.           |
| <b>• Two short 'taps'</b><br>                   | <b>SYS</b><br>At all screens  | Jump to <b>System Menu</b> screen directly.  |
|  | <b>LNK</b><br>At all screens  | Jump to <b>Linkage Menu</b> screen directly. |
|  | <b>MDL</b><br>At all screens  | Jump to <b>Model Menu</b> screen directly.   |
| <b>• Touch and hold for one (1) second.</b><br> | <b>S1</b><br>At the HOME screen   | Key lock On or Off                           |
|  | <b>RTN</b><br>While inputting data with no blinking cursor.                     | Reset to the initialized value.              |
| <b>• Scrolling</b><br>                         | <b>Outline of "RTN"</b><br>Lightly circling the outside edge of the RTN button. | The cursor moves accordingly.                |
|  | During the data input mode.   | Increases or decreases values accordingly.   |

### Movement of cursor, value input or mode selection:

Movement of the cursor on the menu screen and movement of the cursor among items on a setup screen can be controlled by scrolling your finger to the left and right in the direction of the arrow in the scrolling diagram above. You can also go to the next page, if there is a next page.

This scrolling technique is also used for data input, value input, mode selection, and similar operations. Examples include: Value, ON, OFF, INH, ACT, etc.

### RTN button:

Touch the RTN button when you want to open a setup screen or to switch between cursor move mode (reverse display) and data input mode (box display).

This button can also be used as the enter button when a confirmation message is displayed on the screen, etc.

### S1 button:

When there is a next page on a menu screen or setup screen, you can go to that page by touching the S1 button. In this case, the cursor moves to the screen title item of the page.

### Exiting setup screen:

To end the operation on a setup screen and return to the menu screen, move the cursor to the screen title item and touch the RTN button.

To return to home screen directly, touch the S1 button for 1 second.

Alternatively, move the cursor to the screen title item and touch the RTN button to return to the home screen from a menu screen.

**Note:**

\*Scroll operation: Circle your finger on the outside edge of the RTN button. The sensors may mis-read your touch as a reverse rotation if the circle is smaller, or performed on the inside edge of the RTN button.



\* The SensorTouch™ may not operate smoothly if your hand is touching the surrounding case parts. Please make sure that the tip of your finger is actually operating the SensorTouch™.

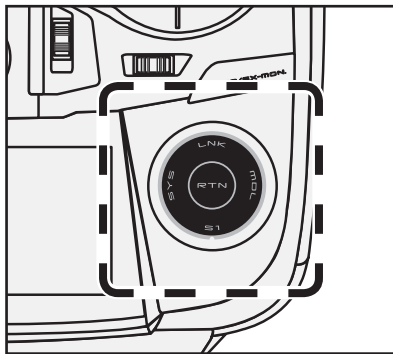

\*If the SensorTouch™ does not register your input, please try again after lightly tapping your finger on the sensor once again.

\*Do not operate the SensorTouch™ while wearing gloves. The SensorTouch™ may not work correctly.

**Caution**

**!** The touch sensor may not operate correctly if spark noise is generated from a gasoline engine, etc. Please remove the transmitter to a location away from the noise source.

**Stick Adjustment**

**Adjustment of the stick lever length**

You can adjust the length of stick levers, as you like. It is recommended to adjust the length of the sticks in line with your hand size.

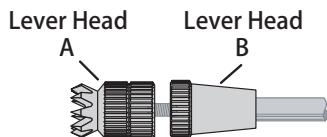

1. Hold the lever head "B" and turn the lever head "A" counter-clockwise. The lock will be released.
2. Turn the lever-head "A" clockwise as you hold the lever-head "B" after placing it as you like.

**Adjustment of stick lever tension**

The tension of the self-return type stick lever can be adjusted.

1. First, Remove the battery cover on the bottom of the transmitter. Next, unplug the battery wire and remove the battery from the transmitter.
2. Next, using a hand, remove the transmitter's side cover (rubber). When using Mode 1, you will need to remove the side cover to expose the tension screw.

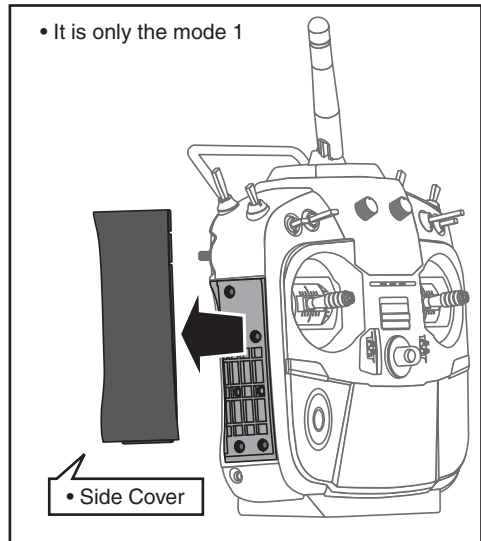

3. Using your hand remove the transmitters rear rubber grips.

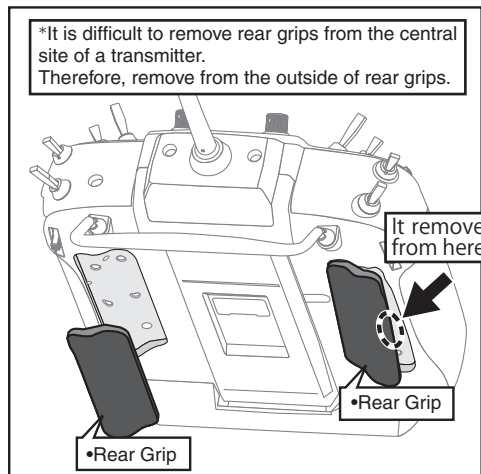

4. Use a small Phillips screwdriver to adjust the spring strength as you prefer by turning the adjusting screw of the stick you want to adjust.

\*Turning the screw clockwise increases the tension.

CAUTION: If you loosen the screw too much, it can interfere with the operation of the sticks internally.

5. At the end of adjustment, re-install the side cover and rear grips.

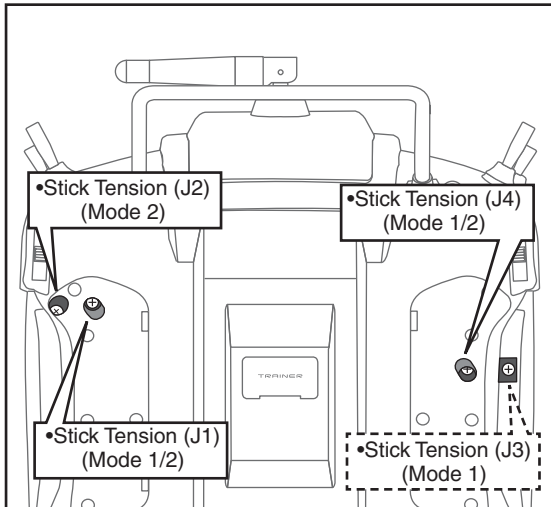

The stick can be adjusted to how quickly it returns to neutral.

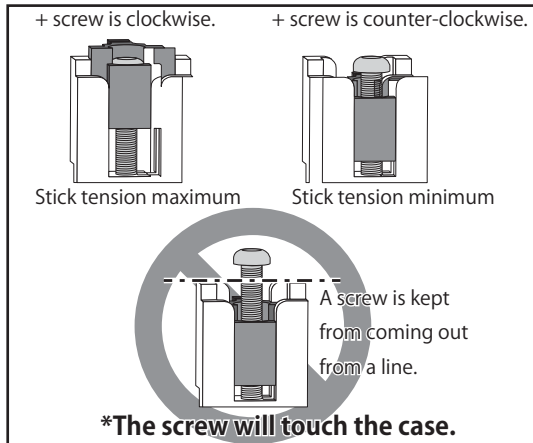
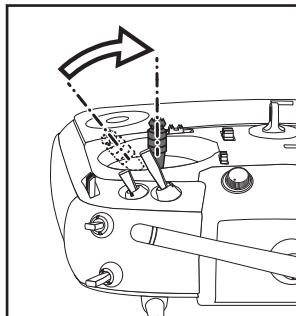

## SD Card (Secure Digital memory card) (Not included)

The T14SG transmitter model data can be stored by using any commonly found SD card. When T14SG transmitter update software is released, the software is updated using an SD card. The T14SG is capable of using SD cards with a memory size SD : 32MB-2GB SDHC : 4GB-32GB.

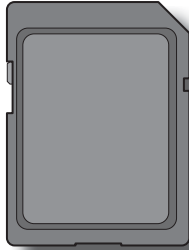

### ⚠ Caution

❗ Be sure to turn off the power to the transmitter before inserting or removing the SD card.

⊘ As the SD card is a precision device, do not use excessive force when inserting.

### Restrictions when using an SD card

The following restrictions apply when using an SD card:

\*The SD card must first be initialized using the T14SG dedicated format. The SD card cannot be used as is without formatting to the T14SG.

\*Initializing destroys all the data previously saved on the card.

\*An SD card formatted to the T14SG cannot be written directly from a PC by Windows Explorer, etc. The files must be converted and written by the Futaba File System software. Files are identified by number instead of name. This special conversion software can be downloaded from Futaba's web site at:

<http://www.futaba-rc.com/software-updates.html>

## Inserting/removing the SD card

1. Turn off the transmitter power and then open the battery cover at the bottom of the transmitter.

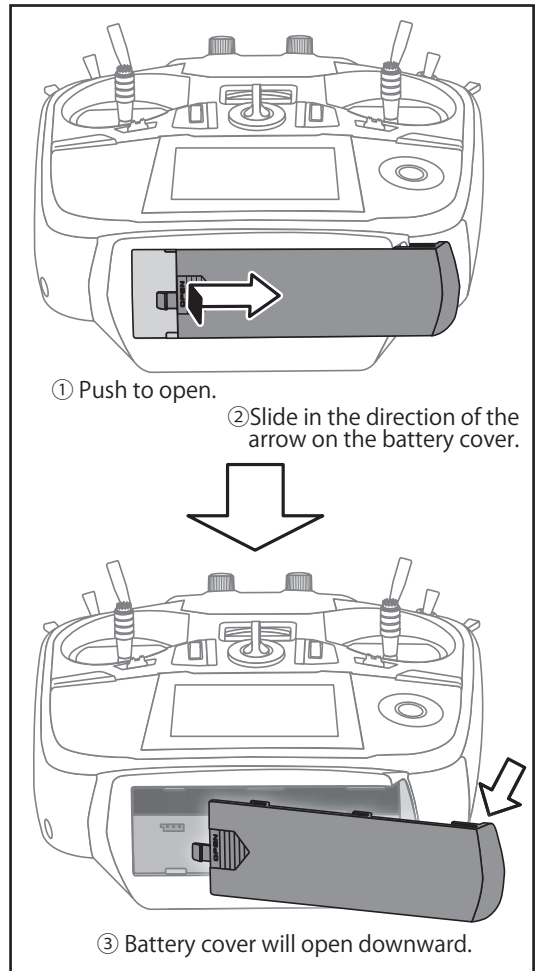

2. The SD card slot is shown here in the figure below.

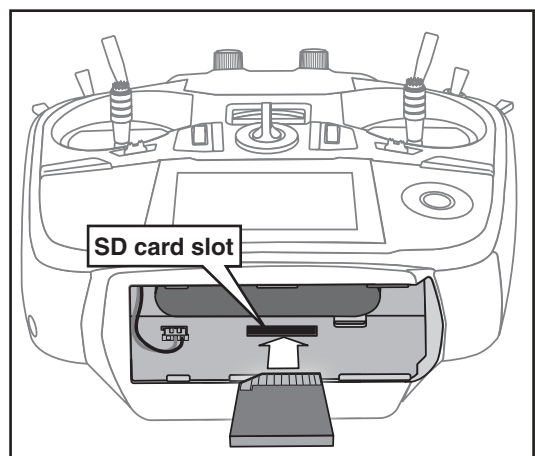

### [Inserting the card]

Turn the SD card so that the front of the card faces the rear of the transmitter and slide the card into the card slot.

\*Push in the card until it is firmly seated in the card slot.

### [Removing the card]

When the SD card is pressed in once again, the card will be released from the card slot. and can be removed.

3. Close the battery cover.

## SD card initialization

To use an SD card with the T14SG, the card must first be formatted. Once formatted, the card does not have to be reformatted. Formatting is performed by the T14SG.

[IMPORTANT] When an SD card is formatted for the T14SG, all pre-existing data is destroyed. **Do not format a card containing important data.**

### [Formatting procedure]

1. Insert the SD card into the SD card slot of the T14SG.
2. Turn on the T14SG power. When an unformatted card is inserted into the T14SG, the screen shown below appears.



3. If the T14SG is ready to format, move the cursor to [FORMAT] and touch the RTN button. (To cancel formatting, move the cursor to [CANCEL] and touch the RTN button.)
4. Move the cursor to [YES] and touch the RTN button.

\*Formatting starts. During formatting, the [NOW FORMATTING...] message is displayed.

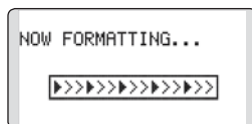

\*When formatting is completed, The [FORMAT COMPLETED] message is displayed. Depending on the card capacity and speed, formatting may take as long as several minutes.



[IMPORTANT] Do not turn off the power until the [FORMAT COMPLETED] message is displayed.

5. End formatting by touching the RTN button.

## SD card reader/writer

Saving model data and update files (released from Futaba) to the SD card from your own PC, you can transfer those file to your T14SG transmitter. Equipment for reading and writing SD cards is available at most electronics stores.

## Stored data

If you have a problem saving or reading data after a long period of use, we suggest obtaining a new SD card to avoid further difficulties.

\*Futaba is not responsible for compensating any failure or damage to the data stored in the memory card. As such, we suggest that you maintain a backup of your important data contained on your SD card.

---

## Connector/Plug

---

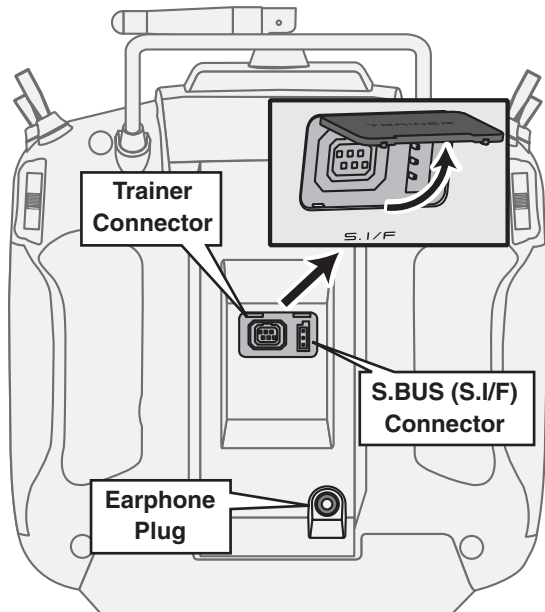

### Connector for trainer function

When you use the trainer function, connect the optional trainer cable between the transmitters for teacher and student.

\*You can set the trainer function on the Trainer Function screen in the System menu.

### S.BUS connector (S.I/F)

When setting an S.BUS servo and telemetry sensor, connect them both here.

(Supply power by 3-way hub or Y-harnesses.)

### Earphone plug

It is not used now. (The function after upgrade)

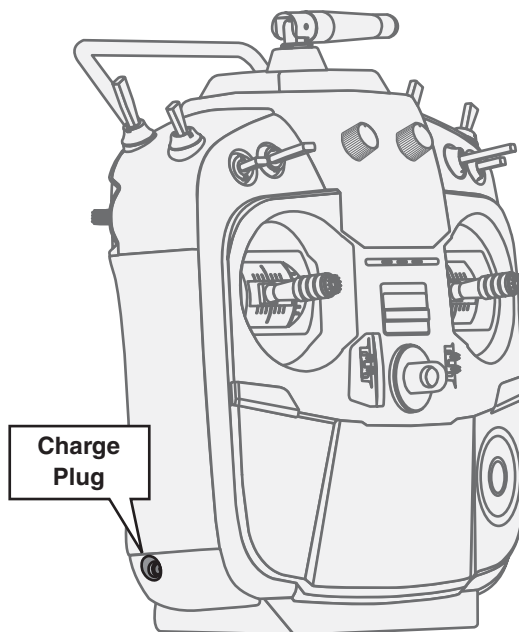

### Connector for battery charger

This is the connector for charging the NiMH battery HT5F1800B that is installed in the transmitter. Do not use any other chargers except the attached special charger corresponding to NiMH battery.

### Warning

 Do not connect any other chargers except the special charger to this charging connector.

\*If you take out the NiMH battery HT5F1800B from the transmitter, you can use the optional quick charger CR-2000 corresponding to NiMH battery.

## Installation and Removal of the HT5F1800B Transmitter Battery

### Attachment of the battery

1. Slide the battery cover on the bottom of the transmitter toward the right side and open it.

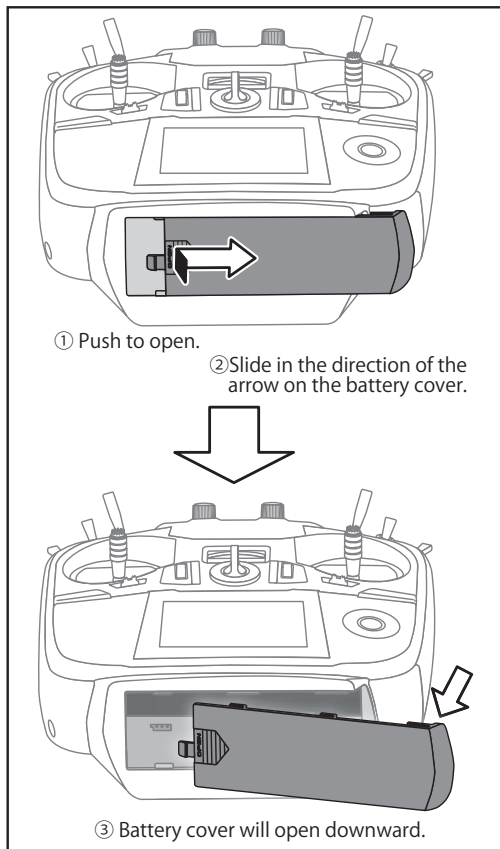

2. Install the battery in the holder.
3. Connect the battery connector.

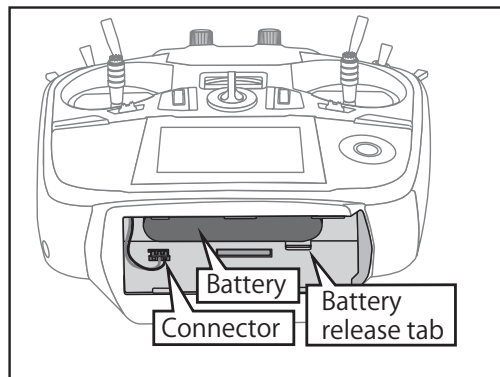

4. Close the battery cover completely.

### Battery Removal

**Note: If you remove the battery while the power is on, the data you have set will not be saved.**

1. Open the battery cover.
2. Disconnect the battery connector.
3. Press on the battery release tab and pull the battery downwards to remove.
4. Close the battery cover completely.

### Warning

 Be careful not to drop the battery.

 Never disconnect the battery connector from the T14SG transmitter after turning off the power until the screen is completely blank and the transmitter has shut down completely.

\* Internal devices such as memories may be damaged.

\* If there is any problem, the message "Backup Error" will be shown the next time when you turn on the power of the transmitter. Do not use the transmitter as it is. Send it to the Futaba Service Center.

**When exchanging for the LiFe battery (FT2F2100B/FT2F1700B) of an option.**

**Attachment of the battery**

1. T14SG to HT5F1800B is removed.
2. A LiFe spacer (14SG attachment) is inserted as shown in a figure.

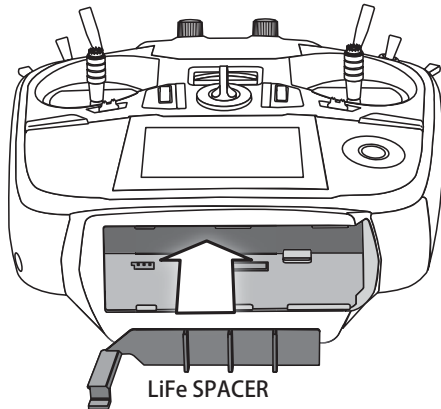

3. A LiFe battery (option) is inserted as shown in a figure.

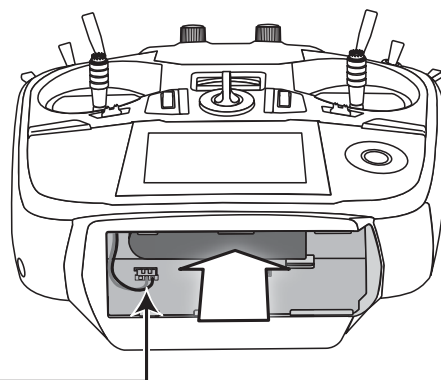

4. 2P connector of a LiFe battery is connected.

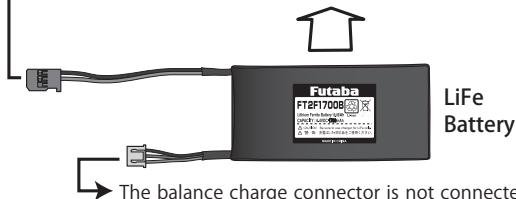

The balance charge connector is not connected in the state where the battery is set to a transmitter.

5. Close the battery cover completely.
6. T14SG is turned on and [LINKAGE MENU]=>[WARNING]=>[LOW BATTERY] is called.
7. It changes into 6.0V from 5.6V.

\*About low battery voltage, all the models included in one transmitter are changed in common. It cannot set to different voltage for every model. Moreover, data reset is not carried out.

**The battery state inside T14SG**

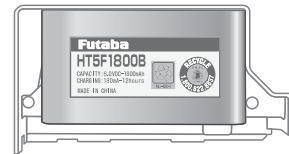

NiMH HT5F1800B

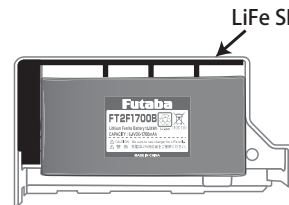

LiFe FT2F2100B/1700B

**Charge of a LiFe battery**

**Note: LiFe battery cannot be charged with the charger of 14SG attachment.**

**Be sure to remove a battery from T14SG and to charge from the charger only for LiFe.**

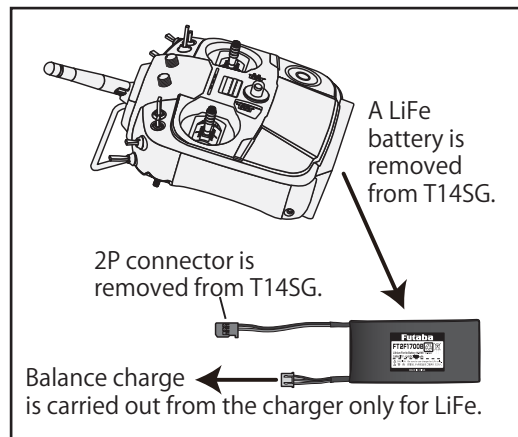

**Warning**

- Follow the manual of a LiFe battery.
- Don't charge the LiFe battery with the NiMH charger of 14SG attachment.
  - \* Be sure to remove from T14SG and to charge with the charger only for LiFe.
- Be sure to change the voltage of LOW BATTERY WARNING into 6.0V from 5.6V



## Receiver nomenclature

Before using the receiver, be sure to read the precautions listed in the following pages.

### Receiver R7008SB

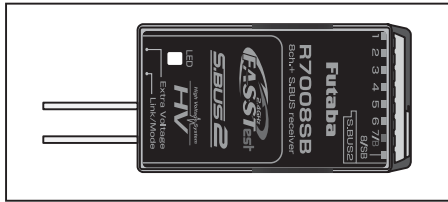

#### Connector

"1 through 6": outputs for the channels 1 through 6

"7/B": outputs of 7 channels and power.

"8/SB": outputs of 8 channels or S.BUS port.

[S.BUS Servo S.BUS Gyro] →

\*When using 8/SB as S.BUS, you have to set CH MODE of the following page to mode B or mode D.

"S.BUS2": outputs of S.BUS2 port. ←

[S.BUS2 Servo S.BUS2 Gyro Telemetry Sensor] ←

\*When using 9 or more channels, use an S.BUS function or use a second R7008SB and link both to your transmitter.

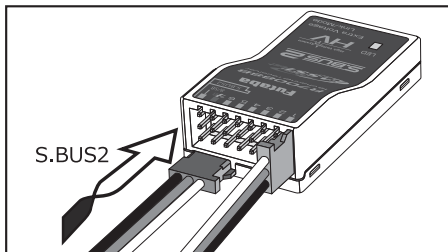

#### Connector insertion

Firmly insert the connector in the direction shown in the figure. Insert the S.BUS2 by turning it 90 degrees.

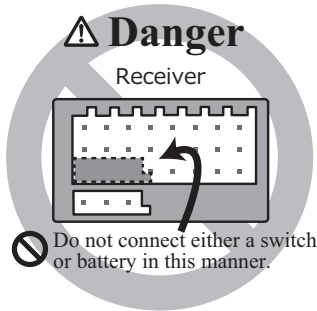

### **Danger**

⊘ Don't connect a connector, as shown in a before figure.

\*It will short-circuit, if it connected in this way. A short circuit across the battery terminals may cause abnormal heating, fire and burns.

### **Warning**

S.BUS2 connectors

⊘ Don't connect an S.BUS servo / gyro to S.BUS2 connector.

#### LED Monitor

This monitor is used to check the CH mode of the receiver.

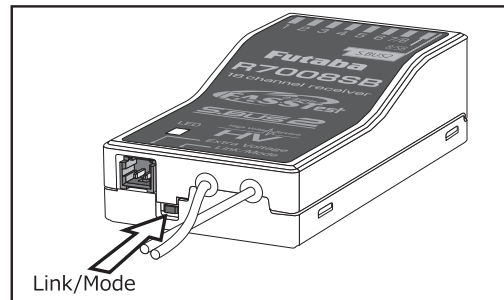

#### Link/Mode Switch

Use the small plastic screw driver that was included with your receiver.

The Link/Mode Switch is also used for the CH mode selection.

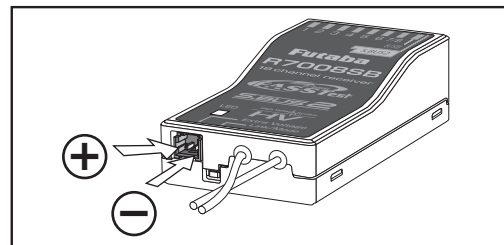

#### Extra Voltage Connector

Use this connector when using a voltage telemetry device to send the battery voltage (DC0 ~ 70V) from the receiver to the transmitter.

You will need to purchase the optional External Voltage input cable (CA-RVIN-700) FUTM5551.

You can then make a cable with an extra connector to the External voltage connector.

## Danger

### Don't touch wiring.

\* There is a danger of receiving an electric shock.

### Do not short-circuit the battery terminals.

\* A short circuit across the battery terminals may cause abnormal heating, fire and burns.

### Please double check your polarity ( + and - ) when hooking up your connectors.

\* If + and - of wiring are mistaken, it will damage, ignite and explode.

### Don't connection to Extra Voltage before turning on a receiver power supply.

## R7008SB CH Mode

The R7008SB receiver is a very versatile unit. It has 8 PWM outputs, S.BUS and S.BUS2 outputs. Additionally the PWM outputs can be changed from channels 1-8 to channels 9-14. If you only desire to use it as an 8 channel receiver (without S.BUS), it can be used without any setting changes.

The T14SG has the ability to link to two R7008SB receivers. One of them outputting channels 1-8 and the other outputting channels 9-14 giving you 14 PWM channels. Instructions for this configuration and S.BUS operation follow.

[How to change the R7008SB Channel mode.]

1. Press and hold down the Link/Mode button on the R7008SB receiver.
2. Turn the receiver on while holding down the Link/Mode button. when the LED begins to blink green/red the button may be released.
3. The LED should now be blinking red in one of the patterns described by the chart below.
4. Each press of the Mode/Link button advances the receiver to the next mode.
5. When you reach the mode that you wish to operate in, press and hold the Mode/Link button for more than 2 seconds.
6. Once locked into the correct mode the LED will change to a solid color.
7. Please cycle the receiver(s) power off and back on again after changing the Channel Mode.

## R7008SB CH MODE TABLE

| Receiver connector | Setting channel   |                   |                    |                    |
|--------------------|-------------------|-------------------|--------------------|--------------------|
|                    | Mode A<br>1 ~ 8CH | Mode B<br>1 ~ 7CH | Mode C<br>9 ~ 14CH | Mode D<br>9 ~ 14CH |
| 1                  | 1                 | 1                 | 9                  | 9                  |
| 2                  | 2                 | 2                 | 10                 | 10                 |
| 3                  | 3                 | 3                 | 11                 | 11                 |
| 4                  | 4                 | 4                 | 12                 | 12                 |
| 5                  | 5                 | 5                 | 13                 | 13                 |
| 6                  | 6                 | 6                 | 14                 | 14                 |
| 7/B                | 7                 | 7                 | -                  | -                  |
| 8/SB               | 8                 | S.BUS             | -                  | S.BUS              |
| Red LED blink      | 1time             | 2time             | 3time              | 4time              |

## Receiver's Antenna Installation

The R7008SB has two antennas. In order to maximize signal reception and promote safe modeling Futaba has adopted a diversity antenna system. This allows the receiver to obtain RF signals on both antennas and fly problem-free.

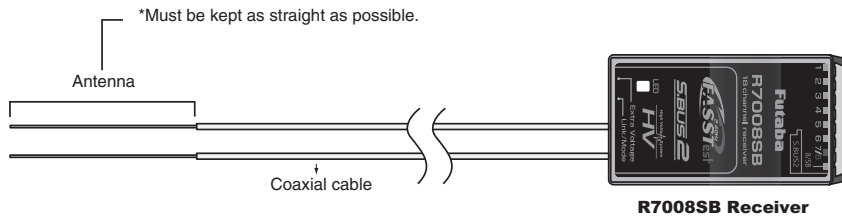

To obtain the best results of the diversity function, please refer to the following instructions:

1. The two antennas must be kept as straight as possible. Otherwise it will reduce the effective range.
2. The two antennas should be placed at 90 degrees to each other.

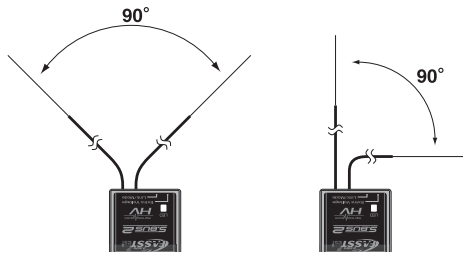

This is not a critical figure, but the most important thing is to keep the antennas away from each other as much as possible.

Larger models can have large metal objects that can attenuate the RF signal. In this case the antennas should be placed at both sides of the model. Then the best RF signal condition is obtained at any flying attitude.

3. The antennas must be kept away from conductive materials, such as metal, carbon and fuel tank by at least a half inch. The coaxial part of the antennas does not need to follow these guidelines, but do not bend it in a tight radius.
4. Keep the antennas away from the motor, ESC, and other noise sources as much as possible.

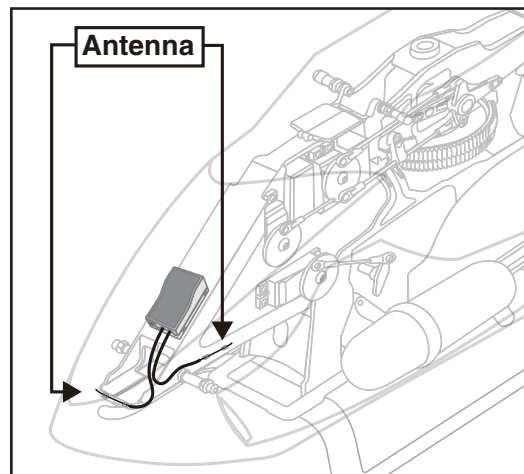
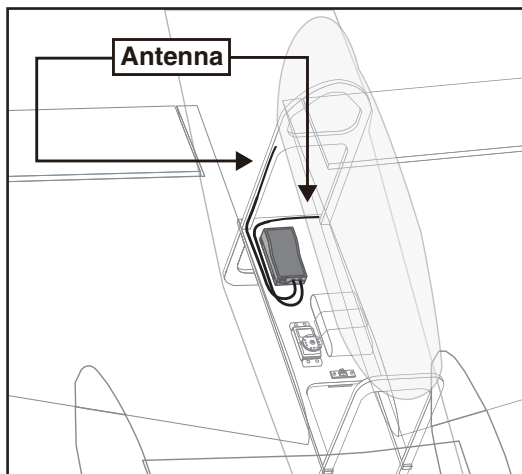

\*The two antennas should be placed at 90 degrees to each other.

\*The Illustration demonstrates how the antenna should be placed.

\*Receiver Vibration and Waterproofing: The receiver contains precision electronic parts. Be sure to avoid vibration, shock, and temperature extremes. For protection, wrap the receiver in foam rubber or other vibration-absorbing materials. It is also a good idea to waterproof the receiver by placing it in a plastic bag and securing the open end of the bag with a rubber band before wrapping it with foam rubber. If you accidentally get moisture or fuel inside the receiver, you may experience intermittent operation or a crash. If in doubt, return the receiver to our service center for service.

## Mounting the Servo

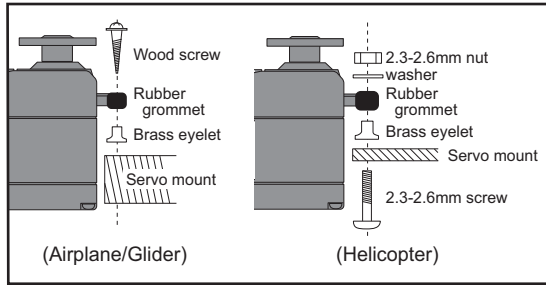

## Servo lead wires

To prevent the servo lead cable from being broken by vibration during flight, provide a little slack in the cable and fasten it at suitable points. Periodically check the cable during daily maintenance.

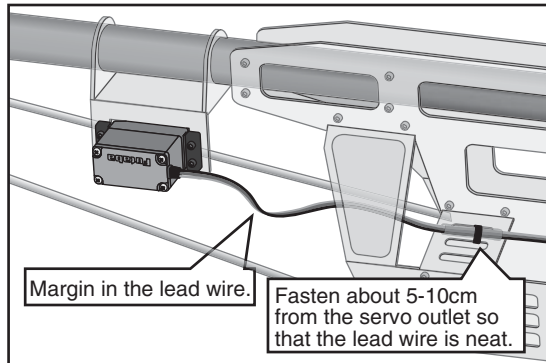

## Mounting the power switch

When mounting a power switch to an airframe, make a rectangular hole that is a little larger than the total stroke of the switch so that you can turn the switch ON/OFF without binding.

Avoid mounting the switch where it can be covered by engine oil and dust. In general, it is recommended to mount the power switch on the side of the fuselage that is opposite the muffler.

## Safety precautions when you install receiver and servos

### **⚠ Warning**

#### Connecting connectors

- ❗ **Be sure to insert the connector until it stops at the deepest point.**

#### How to protect the receiver from vibration and water

- ❗ **Wrap the receiver with something soft such as foam rubber to avoid vibration. If there is a chance of getting wet, put the receiver in a waterproof bag or balloon to avoid water.**

#### Receiver's antenna

- ⊘ **Never cut the receiver's antenna. Do not bind the receiver's antenna with the cables for servos.**

- ❗ **Locate the receiver's antenna as far as possible from metals or carbon fiber components such as frames, cables, etc.**

\*Cutting or binding the receiver's antenna will reduce the radio reception sensitivity and range, and may cause a crash.

#### Servo throw

- ❗ **Adjust your system so that pushrods will not bind or sag when operating the servos to the full extent.**

\*If excessive force is continuously applied to a servo, the servo could be damaged due to force on the gear train and/or power consumption causing rapid battery drain.

#### Mounting servos

- ❗ **Use a vibration-proof rubber (such as rubber grommet) under a servo when mounting the servo on a servo mount. And be sure that the servo cases do not touch directly to the metal parts such as servo mount.**

\*If the servo case contacts the airframe directly, vibration will travel to and possibly damage the servo.

---

## S.BUS/S.BUS2 Installation

This set uses the S.BUS/S.BUS2 system. The wiring is as simplified and clean mounting as possible, even with models that use a large number of servos. In addition, the wings can be quickly installed to the fuselage without any erroneous wiring by the use of only one simple wire, even when there are a large number of servos used.

- When using S.BUS/S.BUS2, special settings and mixes in your transmitter may be unnecessary.
- The S.BUS/S.BUS2 servos memorize the number of channels themselves. (Settable with the T14SG)
- The S.BUS/S.BUS2 system and conventional system (receiver conventional CH used) can be mixed.

S.BUS Glider usage example

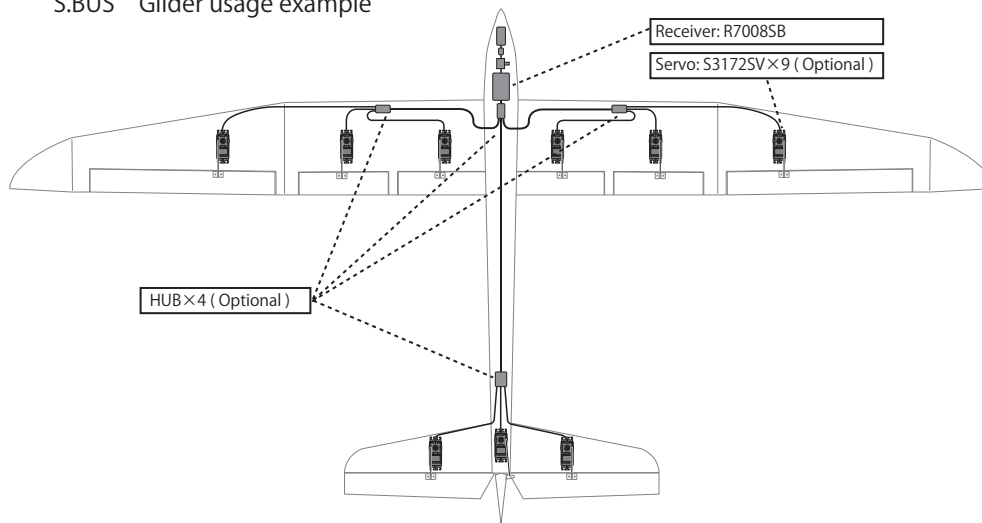

S.BUS Aerobatic plane usage example

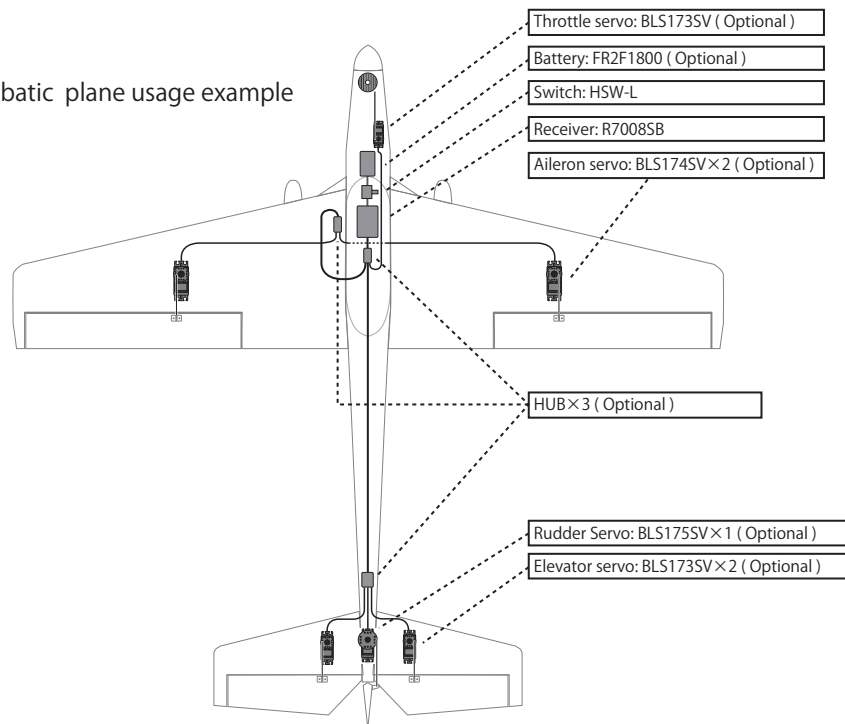

## S.BUS Wiring example

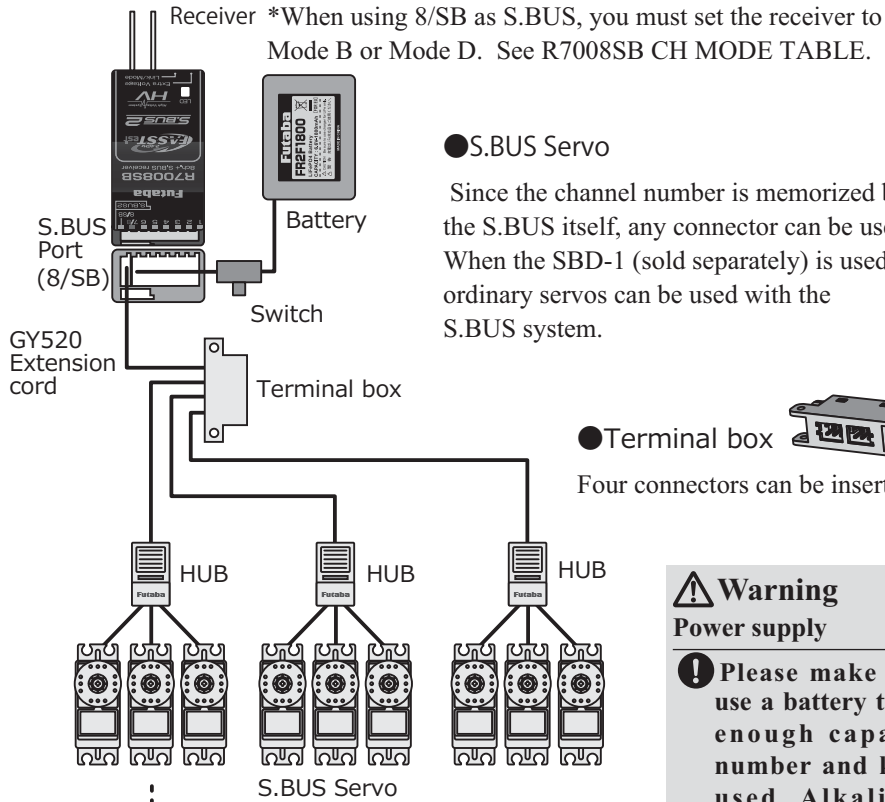

### ● S.BUS Servo

Since the channel number is memorized by the S.BUS itself, any connector can be used. When the SBD-1 (sold separately) is used, ordinary servos can be used with the S.BUS system.

### ● Terminal box

Four connectors can be inserted



### ⚠ Warning Power supply

❗ Please make sure that you use a battery that can deliver enough capacity for the number and kind of servos used. Alkaline batteries cannot be used.

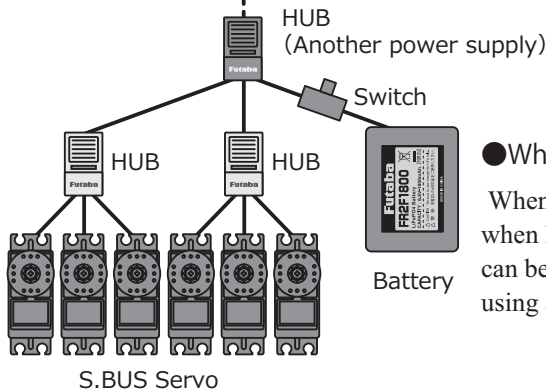

### ● When separate power supply used

When a large number of servos are used or when high current servos are used, the servos can be driven by a separate power supply by using a separate Power Supply 3-way Hub.

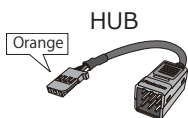

Three connectors can be inserted.

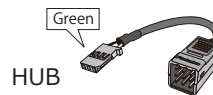

Used when using a separate power supply battery.

## S.BUS2 System

When using the S.BUS2 port, an impressive array of telemetry sensors may be utilized.

### S.BUS2 TABLE

| Receiver port | S.BUS Servo<br>S.BUS Gyro | <b>S.BUS2</b> Servo<br><b>S.BUS2</b> Gyro | Telemetry sensor |
|---------------|---------------------------|---|------------------|
| S.BUS         | ○                         | ○   | ×                |
| <b>S.BUS2</b> | ×                         | ○   | ○                |

(※) Don't connect S.BUS Servo,  
S.BUS Gyro to S.BUS2 connector.

**S.BUS servos and gyros and S.BUS2 servos and gyros must be used in the correct receiver ports. Please refer to the instruction manual to make sure you connect to the correct one.**

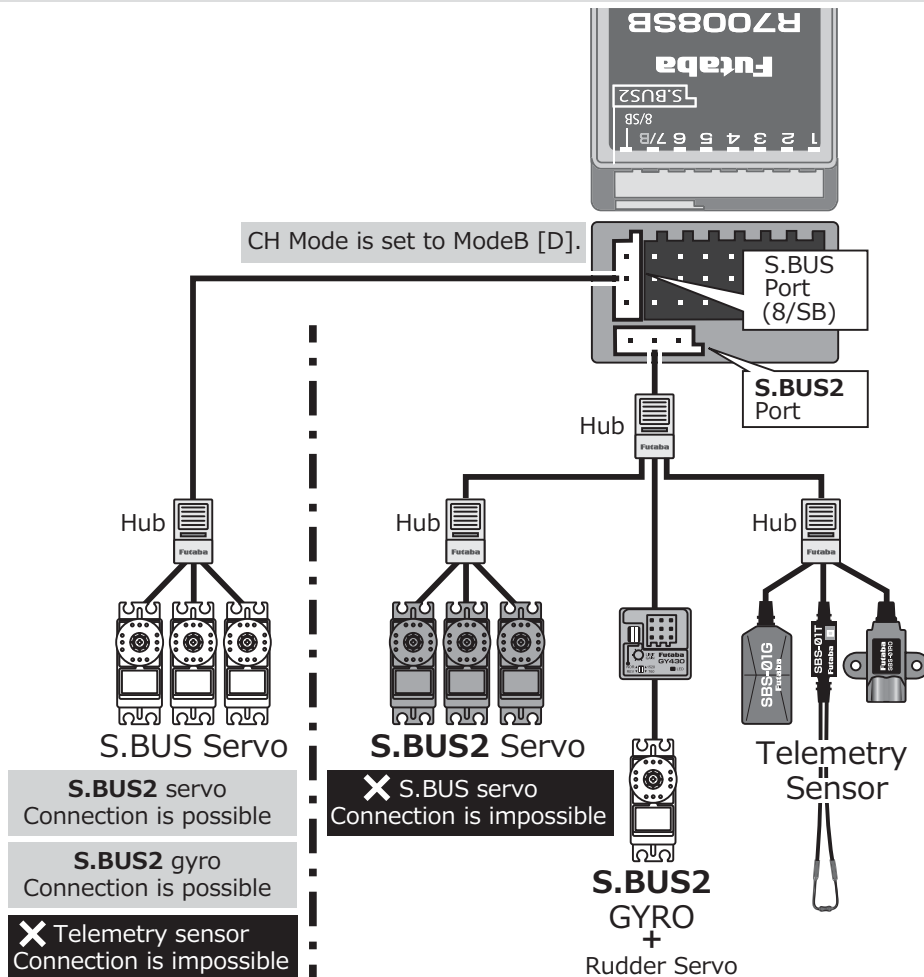

---

## S.BUS/S.BUS2 device setting

S.BUS/S.BUS2 servos or a telemetry sensor can be connected directly to the T14SG. Channel setting and other data can be entered for the S.BUS/S.BUS2 servos or sensors.

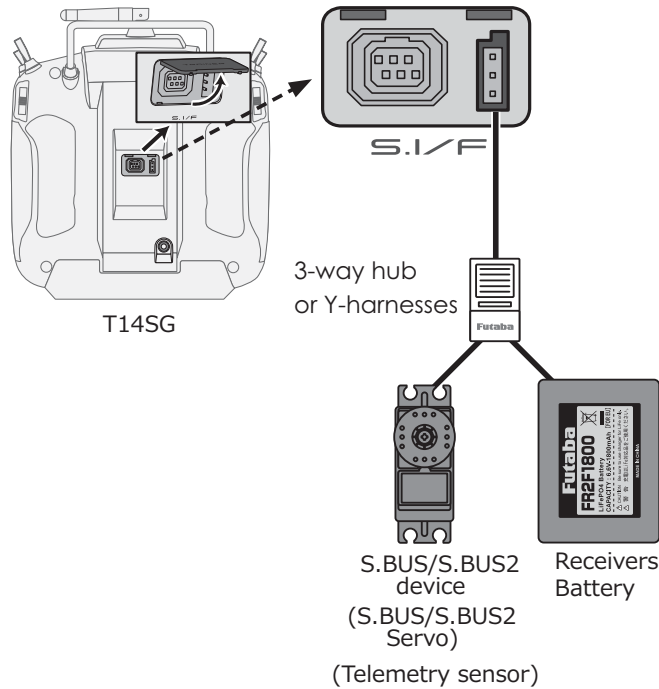

1. Connect the S.BUS device and battery you want to set with a 3-way hub or Y-harnesses as shown in the figure.
2. Turn on the transmitter power.
3. Call the setup screen.  
Servo: System Menu → S.BUS Servo  
Sensor: Linkage Menu → Sensor
4. Perform setting in accordance with each screen.
5. This sets the channel and other data for each S.BUS servo, or telemetry device to be used with the S.BUS device or receiver.





# BASIC OPERATION

## Battery Charging

Before charging batteries, read the "Cautions for handling battery and battery charger" in the section "NiMH/NiCd Battery Safety and Handling Instructions".

### How to charge the NiMH battery HT5F1800B for the transmitter

#### Danger

 The NiMH battery HT5F1800B is only for your T14SG. Do not use this battery for other equipment.

 Be sure to use the attached special charger to charge the battery.

\*If you take the NiMH battery HT5F1800B out of the transmitter, you can use the optional quick charger CR-2000 corresponding to NiMH battery.

\*Battery charging will not automatically stop. Remove the battery and transmitter from the charger and remove the charger from the wall socket.

\*It is recommended to reactivate the battery by cycling several times if the battery has not been used for a long period.

\*In the case of NiMH/NiCd batteries, you may find poor performance of the battery if you have used the battery only for a short period or if you repeat charging while the battery is not fully discharged. It is suggested to discharge the battery to the recommended level after use. It is also recommended to charge the battery just before use.

[Method of charging battery]

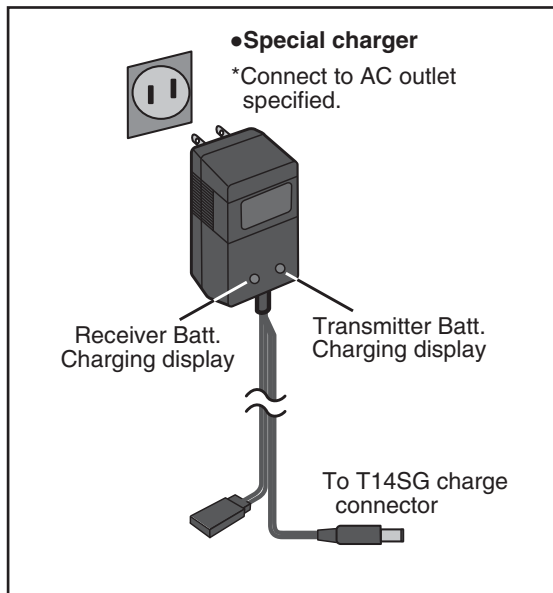

1. Connect the special charger to the wall socket (AC outlet).
2. Connect the connectors to the T14SG charging jack.
  - \*Confirm that the charging indicator, LED lamp, is on.
  - \*Turn off the transmitter while charging the battery.
3. Remove the battery after 15 hours.

---

## How to turn transmitter power ON/OFF

When turning on the power, the T14SG transmitter will begin emitting RF automatically after it confirms the surrounding RF conditions.

The T14SG transmitter also offers the ability to auto shut-down.

### When turning on the power of the transmitter

THR Stick Slow

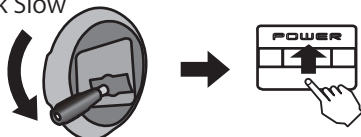

1. Turn on the power switch of the transmitter.

\*The message "CHECK RF CONDITION" is displayed for a moment. At the same time the left LED monitor blinks.



2. Then, you will see the home screen and the transmitter begins to emit radio waves.

\*The left and right LED monitors will change to solid red.

### How to stop the transmitter

1. Turn off the power switch of the transmitter.

\*The transmitter shuts down at once.

### Low battery alarm and auto shut-down

When the battery voltage reaches 5.2V, an audible alarm will sound. Land your aircraft immediately.

When the battery voltage reaches 3.9V, the transmitter will be turned off automatically.

\*If you do not operate the transmitter (or move a stick, knob, switch or digital trim) for 30 minutes, the message "PLEASE TURN OFF POWER SWITCH" is displayed and an audible alarm will sound.

### Warning display at power ON (Airplane/Helicopter)

When the throttle stick during Power On is at the high side (or over 1/3 stick) a warning will be displayed.

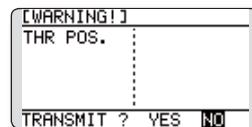

\*below 1/3 stick, the warning display goes off.

---

## Registration of the user's name

If so desired, the T14SG transmitter can indicate the owner's name.

### User's name setup screen

1. Turn on the power of the transmitter.

\*The home screen appears.

2. Lightly touch the SYS button twice rapidly and the System menu appears.

3. Select [USER NAME] in the System menu and touch the RTN button.

\*The user name set up screen appears.

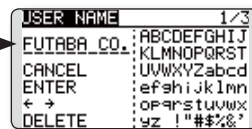

Input Box

\*Current user name is displayed.

### Changing the user name

1. Change the user name as described below:

[Moving cursor in input box]

Select [←] or [→], and touch the RTN button.

[Deleting a character]

When [DELETE] is selected and the RTN button is touched, the character immediately after the cursor is deleted.

[Adding a character]

When a character is selected from the character list and the RTN button is touched, that character is added at the position immediately after the cursor.

\*A name of up to 10 characters long can be entered as the user name. (A space is also counted as one character.)

2. At the end of input, select [ENTER] and touch the RTN button. (To terminate input and return to the original state, select [CANCEL] and touch the RTN button.)

## Home screen

Use the touch sensor to select the following display area to call each setting screen, and touch the RTN button. The setting screen appears.

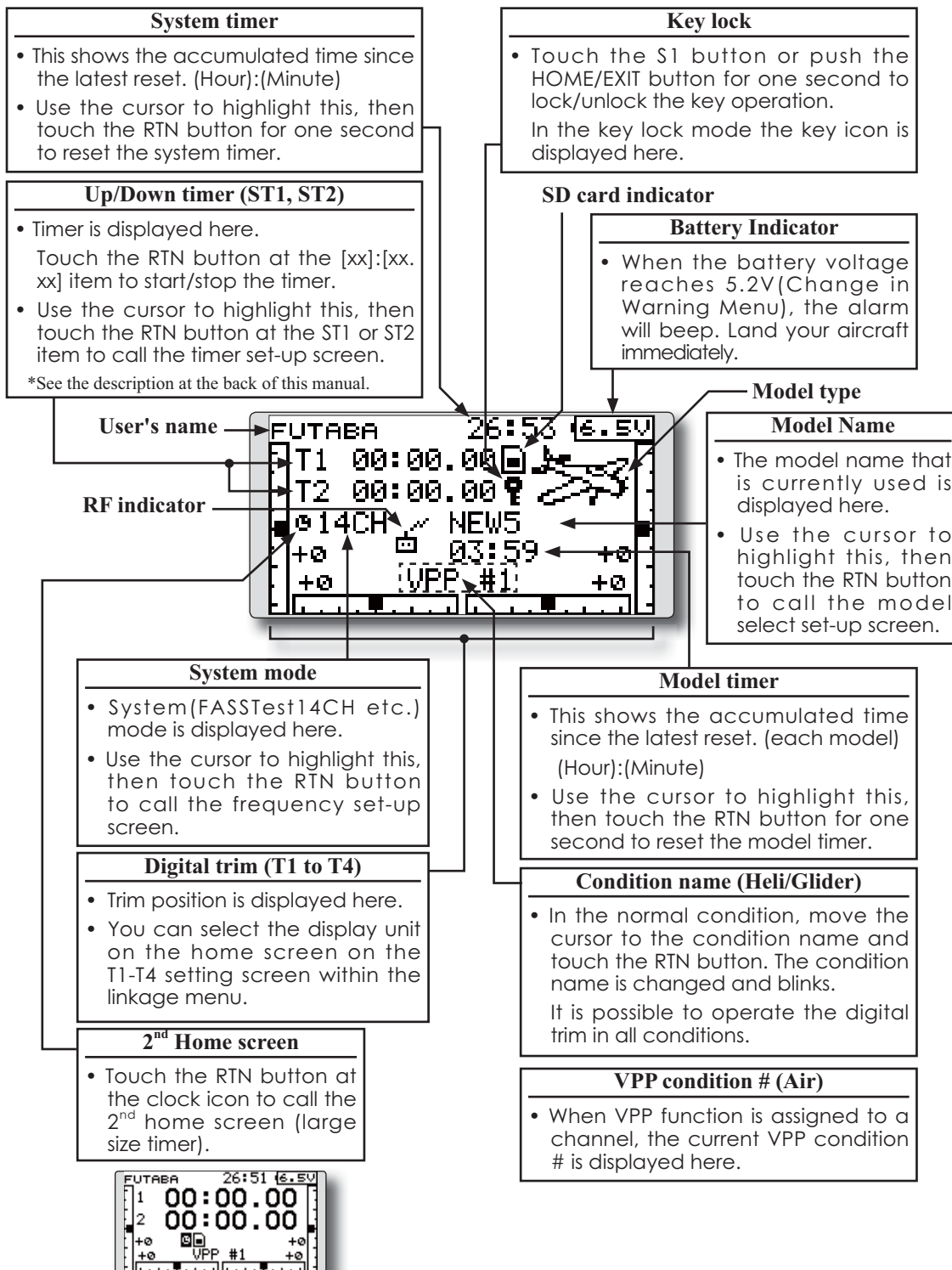

---

## User Menu

A user menu which allows the user to customize and display frequently used functions has been added.

1. When the "U.MENU" button is pushed for two seconds, the user menu appears.

\*Return to the home screen by touching the EXIT button while the user menu is being displayed.

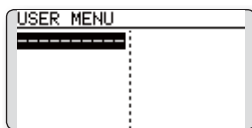

2. When the cursor highlights the dotted line, "-----" and the RTN button is touched, the menu selection screen appears.

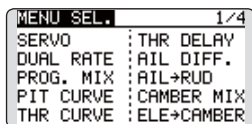

3. When the cursor is moved to the setting that you to set to the user menu and the RTN button is touched, that setting screen is added to the user menu.
4. The registered setting screen can be called by moving the cursor to it and touching the RTN button.

\*When you want to delete an added screen from the user menu, highlight item you wish to delete, press and hold the RTN button for one second.

## Warning

- ! Be sure to confirm the model name before flying your aircraft.
- ! Check the battery voltage as often as possible and try to charge the battery earlier. If the battery alarm makes a sound, land your aircraft immediately.

## Link procedure (T14SG/R7008SB)

Each transmitter has an individually assigned, unique ID code. In order to start operation, the receiver must be linked with the ID code of the transmitter with which it is being paired. Once the link is made, the ID code is stored in the receiver and no further linking is necessary unless the receiver is to be used with another transmitter. When you purchase additional R7008SB receivers, this procedure is necessary; otherwise the receiver will not work.

### Link procedure

1. Place the transmitter and the receiver close to each other within half (0.5m) meter.

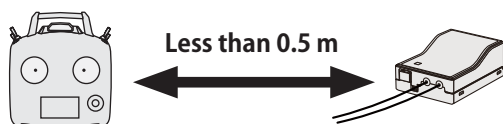

2. Turn on the transmitter.
3. Select [SYSTEM] at the Linkage menu and access the setup screen shown below by touching the RTN button.

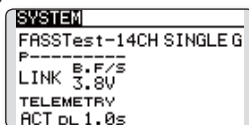

:You can do this through the LINKAGE Menu and scroll to System and press RTN.

4. When you use two receivers on one model, you must change from [SINGLE] to [DUAL].

\*Only two receivers can be used. In "DUAL", two setting items come out. Input, respectively.

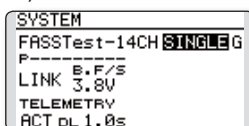

ID of a Primary receiver displays.

ID of a Secondary receiver displays.

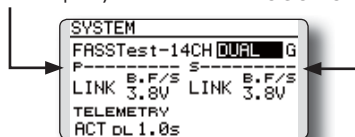

In DUAL, a primary receiver is link previously. Next, a secondary receiver is link.

5. "F" will be chosen if it is used in France. others "G" general.

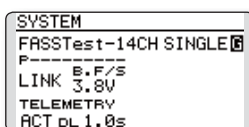

6. When changing battery fail-safe voltage from the initial value 3.8V, voltage is changed here.

\* Only in FASSTest Mode.

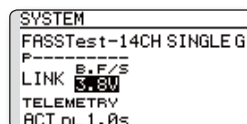

7. [LINK] is chosen by scrolling and the RTN button is pushed. The transmitter will emit a chime as it starts the linking process.

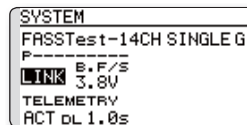

8. When the transmitter starts to chime, power on the receiver. The receiver should link to the transmitter within about 1 second.

### In "Link" Mode



9. If linking fails, an error message is displayed. Bring the transmitter closer to the receiver and repeat the procedure above from Step 2.

10. ACT will be chosen if telemetry is used. It is INH when not using it.

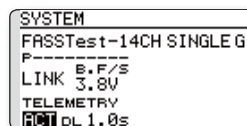

---

11. When a telemetry function is enabled, the receiving interval (down-link interval) of sensor data can be changed. If a DL interval is increased, the response of the sensor data display becomes slower, but stick response will improve.

Initial value: 1.0s

Adjustment range: 0.1s~2.0s

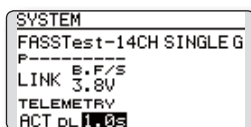

\*If there are many FASSTest systems turned on around your receiver, it might not link to your transmitter. In this case, even if the receiver's LED stays solid green, unfortunately the receiver might have established a link to one of other transmitters. This is very dangerous if you do not notice this situation. In order to avoid the problem, we strongly recommend you to doublecheck whether your receiver is really under control by your transmitter by giving the stick input and then checking the servo response.

\*Do not perform the linking operation when the drive motor is connected or the engine is running.

\* When you use two receivers, please be sure to setup a "primary" and "secondary" in the "dual" mode.

\*Since two sets of receivers cannot be individually recognized without using a "primary" and "secondary" setup, it is impossible to receive telemetry data correctly.

\* You must link one receiver at a time. If both power supplies to the receivers are switched on simultaneously, data is received incorrectly by the transmitter.

\* If a dual receiver function is used, in order to receive sensor information correctly by both sets, telemetry data will be slower compared to a single receiver setup.

\* You cannot link three receivers.

\* Link is required when a system type is changed.

\* Linking is required whenever a new model is made.

\* Link is required when a system type is changed.

### Warning

 After the linking is done, please cycle receiver power and check that the receiver to be linked is really under the control of the transmitter.

 Do not perform the linking procedure with motor's main wire connected or with the engine operating as it may result in serious injury.

---

## Range Testing Your R/C System

It is extremely important to range check your models prior to each flying session. This enables you to ensure that everything is functioning as it should and to obtain maximum enjoyment from your time flying. The T14SG transmitter incorporates a system that reduces its power output and allows you to perform such a range check.

### Range check mode

We have installed a special "Range check mode" for doing a ground range check. To access the "Range check mode" touch and hold the RTN button while turning on the transmitter. Doing so will bring up POWER MODE menu.

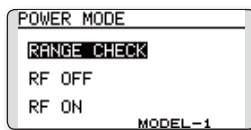

↑ The present model

To activate the "Range check mode" touch the RTN button and the range check mode screen will appear.



During this mode, the RF power output is reduced so the range test can be performed. In addition, when this mode is activated the right LED on the front of the transmitter starts blinking and the transmitter gives users a warning with a beeping sound every 3 seconds.

The "Range check mode" continues for 90 seconds and after that the power will return to the normal level. To exit the "Range check mode" before the 90 seconds, select the "RANGE CHECK" at the top of the screen and touch the RTN button again. This mode is available one time only so if you need to re-use this function the transmitter power must be cycled. NEVER start flying when the "Range check mode" is active.

Should you require additional time to perform a range check, highlight Restart before your time expires and press the RTN button one time.

### Range check procedure

1. With the "Range check mode" on, walk away from the model while simultaneously operating the controls. Have an assistant stand by the model to confirm that all controls are completely and correctly operational. You should be able to walk approximately 30-50 paces from the model without losing control.
2. If everything operates correctly, return to the model. Set the transmitter in a safe, yet accessible, location so it will be within reach after starting the engine or motor. Be certain the throttle stick is in the low throttle position, then start the engine or motor. Perform another range check with your assistant holding the aircraft with the engine running at various speeds. If the servos jitter or move inadvertently, there may be a problem. We would strongly suggest you do not fly until the source of the difficulty has been determined. Look for loose servo connections or binding pushrods. Also, be certain that the battery has been fully charged.

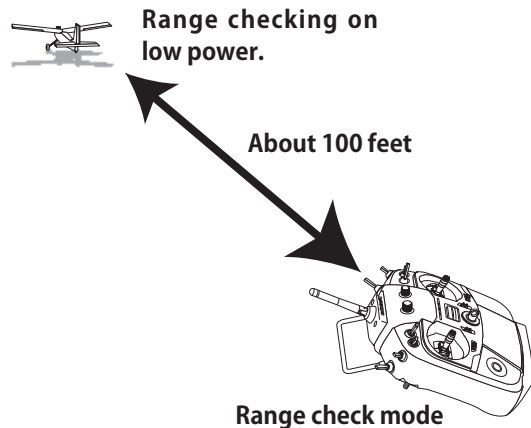

### Warning

! Do not fly in the range check mode.

\*Since the range of the radio waves is short, if the model is too far from the transmitter, control will be lost and the model will crash.



# RECEIVER AND SERVO INSTALLATION

## Receiver and servos connection

Connect the receiver and servos in accordance with the connection diagram shown below. Always read the section [Before using]. When mounting the receiver and servos to the fuselage, connect the necessary points in accordance with the model's instruction manual.

### Receiver and servos connection diagram

Always connect the necessary number of servos.

The receiver channel assignment depends on the model type. See the Servo connection by model type tables.

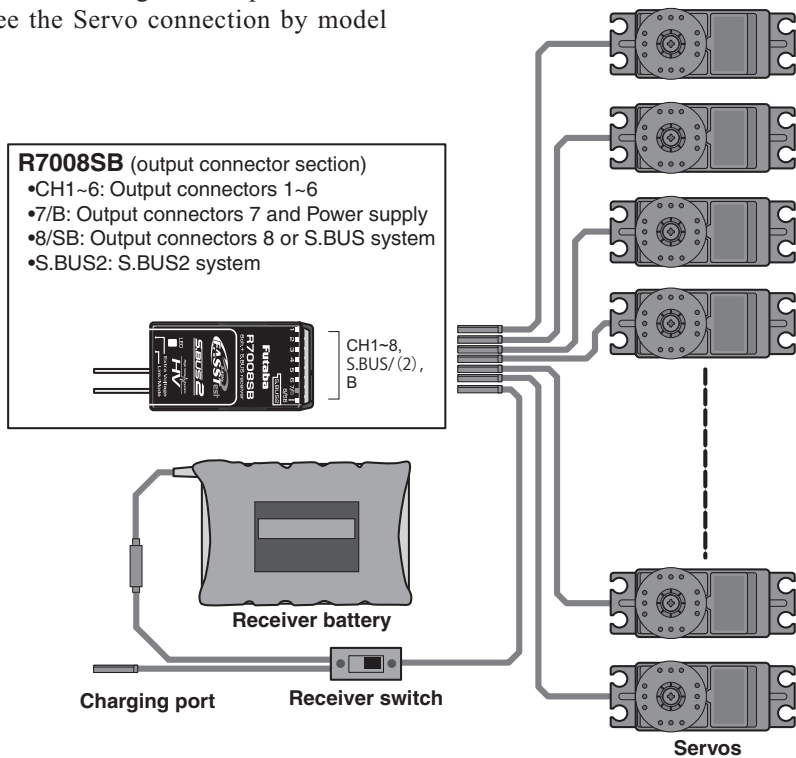

## Servo connection by model type

The T14SG transmitter channels are automatically assigned for optimal combination according to the type selected with the Model Type function of the Linkage Menu. The channel assignment (initial setting) for each model type is shown below. Connect the receiver and servos to match the type used.

\*The set channels can be checked at the Function screen of the Linkage Menu. The channel assignments can also be changed. For more information, read the description of the Function menu.

### Airplane/glider

#### Normal wing and V-tail

| R<br>X | 1Aileron |          | 2Aileron |           | 2Aileron+1FLAP |           | 2Aileron+2FLAP |           | 2Aileron+4FLAP |           | 4Aileron+2FLAP |           | The output<br>CH of each<br>system                |
|--------|----------|----------|----------|-----------|----------------|-----------|----------------|-----------|----------------|-----------|----------------|-----------|---|
|        | Airplane | Glider   | Airplane | Glider    | Airplane       | Glider    | Airplane       | Glider    | Airplane       | Glider    | Airplane       | Glider    |   |
| 1      | Aileron  | Aileron  | Aileron  | Aileron   | Aileron        | Aileron   | Aileron        | Aileron   | Aileron        | Aileron   | Aileron        | Aileron   | FASTest 14CH<br>FASTest 12CH<br>S.FHSS<br>FAST7CH |
| 2      | Elevator | Elevator | Elevator | Elevator  | Elevator       | Elevator  | Elevator       | Elevator  | Elevator       | Elevator  | Elevator       | Elevator  |   |
| 3      | Throttle | Motor    | Throttle | Motor     | Throttle       | Motor     | Throttle       | Motor     | Rudder         | Rudder    | Rudder         | Rudder    |   |
| 4      | Rudder   | Rudder   | Rudder   | Rudder    | Rudder         | Rudder    | Rudder         | Rudder    | Aileron2       | Aileron2  | Aileron2       | Aileron2  |   |
| 5      | Gear     | AUX7     | Gear     | AUX7      | Gear           | AUX6      | Gear           | AUX5      | Flap           | Flap      | Aileron3       | Aileron3  |   |
| 6      | VPP      | AUX6     | Aileron2 | Aileron2  | Flap           | Flap      | Aileron2       | Aileron2  | Flap2          | Flap2     | Aileron4       | Aileron4  |   |
| 7      | AUX5     | AUX5     | VPP      | AUX6      | Aileron2       | Aileron2  | Flap           | Flap      | Flap3          | Flap3     | Flap           | Flap      |   |
| 8      | AUX4     | AUX4     | AUX5     | AUX5      | VPP            | AUX5      | Flap2          | Flap2     | Flap4          | Flap4     | Flap2          | Flap2     |   |
| 9      | AUX1     | AUX1     | Camber   | Camber    | Camber         | Camber    | Camber         | Camber    | Camber         | Camber    | Camber         | Camber    |   |
| 10     | AUX1     | AUX1     | AUX1     | Butterfly | AUX1           | Butterfly | VPP            | Butterfly | Gear           | Butterfly | Gear           | Butterfly |   |
| 11     | AUX1     | AUX1     | AUX1     | AUX1      | AUX1           | AUX1      | AUX1           | AUX1      | Throttle       | Motor     | Throttle       | Motor     |   |
| 12     | AUX1     | AUX1     | AUX1     | AUX1      | AUX1           | AUX1      | AUX1           | AUX1      | VPP            | AUX1      | VPP            | AUX1      |   |
| DG1    | SW       | SW       | SW       | SW        | SW             | SW        | SW             | SW        | SW             | SW        | SW             | SW        |   |
| DG2    | SW       | SW       | SW       | SW        | SW             | SW        | SW             | SW        | SW             | SW        | SW             | SW        |   |

#### Ailvator (Dual Elevator)

| R<br>X | 1Aileron  |           | 2Aileron  |           | 2Aileron+1FLAP |           | 2Aileron+2FLAP |           | 2Aileron+4FLAP |           | 4Aileron+2FLAP |           | The output<br>CH of each<br>system                |
|--------|-----------|-----------|-----------|-----------|----------------|-----------|----------------|-----------|----------------|-----------|----------------|-----------|---|
|        | Airplane  | Glider    | Airplane  | Glider    | Airplane       | Glider    | Airplane       | Glider    | Airplane       | Glider    | Airplane       | Glider    |   |
| 1      | Aileron   | Aileron   | Aileron   | Aileron   | Aileron        | Aileron   | Aileron        | Aileron   | Aileron        | Aileron   | Aileron        | Aileron   | FASTest 14CH<br>FASTest 12CH<br>S.FHSS<br>FAST7CH |
| 2      | Elevator  | Elevator  | Elevator  | Elevator  | Elevator       | Elevator  | Elevator       | Elevator  | Elevator       | Elevator  | Elevator       | Elevator  |   |
| 3      | Throttle  | Motor     | Throttle  | Motor     | Throttle       | Motor     | Throttle       | Motor     | Rudder         | Rudder    | Rudder         | Rudder    |   |
| 4      | Rudder    | Rudder    | Rudder    | Rudder    | Rudder         | Rudder    | Rudder         | Rudder    | Aileron2       | Aileron2  | Aileron2       | Aileron2  |   |
| 5      | Gear      | AUX7      | Gear      | AUX7      | Gear           | AUX6      | Elevator2      | Elevator2 | Flap           | Flap      | Aileron3       | Aileron3  |   |
| 6      | VPP       | AUX6      | Aileron2  | Aileron2  | Flap           | Flap      | Aileron2       | Aileron2  | Flap2          | Flap2     | Aileron4       | Aileron4  |   |
| 7      | Elevator2 | Elevator2 | Elevator2 | Elevator2 | Aileron2       | Aileron2  | Flap           | Flap      | Flap3          | Flap3     | Flap           | Flap      |   |
| 8      | AUX4      | AUX4      | VPP       | AUX5      | Elevator2      | Elevator2 | Flap2          | Flap2     | Flap4          | Flap4     | Flap2          | Flap2     |   |
| 9      | AUX1      | AUX1      | Camber    | Camber    | Camber         | Camber    | Camber         | Camber    | Camber         | Camber    | Camber         | Camber    |   |
| 10     | AUX1      | AUX1      | AUX1      | Butterfly | VPP            | Butterfly | Gear           | Butterfly | Gear           | Butterfly | Gear           | Butterfly |   |
| 11     | AUX1      | AUX1      | AUX1      | AUX1      | AUX1           | AUX1      | VPP            | AUX1      | Throttle       | Motor     | Throttle       | Motor     |   |
| 12     | AUX1      | AUX1      | AUX1      | AUX1      | AUX1           | AUX1      | AUX1           | AUX1      | Elevator2      | Elevator2 | Elevator2      | Elevator2 |   |
| DG1    | SW        | SW        | SW        | SW        | SW             | SW        | SW             | SW        | SW             | SW        | SW             | SW        |   |
| DG2    | SW        | SW        | SW        | SW        | SW             | SW        | SW             | SW        | SW             | SW        | SW             | SW        |   |

## Airplane/glider

### Flying wing, Delta wing

| R<br>X | 2Aileron |          | 2Aileron+1FLAP |           | 2Aileron+2FLAP |           | 2Aileron+4FLAP |           | 4Aileron+2FLAP |           | The output<br>CH of each<br>system                               |
|--------|----------|----------|----------------|-----------|----------------|-----------|----------------|-----------|----------------|-----------|--|
|        | Airplane | Glider   | Airplane       | Glider    | Airplane       | Glider    | Airplane       | Glider    | Airplane       | Glider    |  |
| 1      | Aileron  | Aileron  | Aileron        | Aileron   | Aileron        | Aileron   | Aileron        | Aileron   | Aileron        | Aileron   | FASSTest 14CH FASST MULT<br>FASSTest 12CH<br>S-FHSS<br>FASST 7CH |
| 2      | VPP      | AUX4     | VPP            | AUX4      | VPP            | AUX4      | Aileron2       | Aileron2  | Aileron2       | Aileron2  |  |
| 3      | Throttle | Motor    | Throttle       | Motor     | Throttle       | Motor     | Rudder         | Rudder    | Aileron3       | Aileron3  |  |
| 4      | Rudder   | Rudder   | Rudder         | Rudder    | Rudder         | Rudder    | VPP            | AUX4      | Aileron4       | Aileron4  |  |
| 5      | Gear     | AUX7     | Gear           | AUX6      | Gear           | AUX6      | Flap           | Flap      | Rudder         | Rudder    |  |
| 6      | Aileron2 | Aileron2 | Flap           | Flap      | Flap           | Flap      | Flap2          | Flap2     | VPP            | AUX4      |  |
| 7      | AUX6     | AUX6     | Aileron2       | Aileron2  | Aileron2       | Aileron2  | Flap3          | Flap3     | Flap           | Flap      |  |
| 8      | AUX5     | AUX5     | AUX5           | AUX5      | Flap2          | Flap2     | Flap4          | Flap4     | Flap2          | Flap2     |  |
| 9      | Elevator | Elevator | Elevator       | Elevator  | Elevator       | Elevator  | Elevator       | Elevator  | Elevator       | Elevator  |  |
| 10     | Camber   | Camber   | Camber         | Camber    | Camber         | Camber    | Camber         | Camber    | Camber         | Camber    |  |
| 11     | AUX1     | AUX1     | AUX1           | Butterfly | AUX1           | Butterfly | Gear           | Butterfly | Gear           | Butterfly |  |
| 12     | AUX1     | AUX1     | AUX1           | AUX1      | AUX1           | AUX1      | Throttle       | Motor     | Throttle       | Motor     |  |
| DG1    | SW       | SW       | SW             | SW        | SW             | SW        | SW             | SW        | SW             | SW        |  |
| DG2    | SW       | SW       | SW             | SW        | SW             | SW        | SW             | SW        | SW             | SW        |  |

### Flying wing, Delta wing (Winglet 2 Rudder)

| R<br>X | 2Aileron |          | 2Aileron+1FLAP |           | 2Aileron+2FLAP |           | 2Aileron+4FLAP |           | 4Aileron+2FLAP |           | The output<br>CH of each<br>system                               |
|--------|----------|----------|----------------|-----------|----------------|-----------|----------------|-----------|----------------|-----------|--|
|        | Airplane | Glider   | Airplane       | Glider    | Airplane       | Glider    | Airplane       | Glider    | Airplane       | Glider    |  |
| 1      | Aileron  | Aileron  | Aileron        | Aileron   | Aileron        | Aileron   | Aileron        | Aileron   | Aileron        | Aileron   | FASSTest 14CH FASST MULT<br>FASSTest 12CH<br>S-FHSS<br>FASST 7CH |
| 2      | Rudder2  | Rudder2  | Rudder2        | Rudder2   | Rudder2        | Rudder2   | Aileron2       | Aileron2  | Aileron2       | Aileron2  |  |
| 3      | Throttle | Motor    | Throttle       | Motor     | Throttle       | Motor     | Rudder         | Rudder    | Aileron3       | Aileron3  |  |
| 4      | Rudder   | Rudder   | Rudder         | Rudder    | Rudder         | Rudder    | Rudder2        | Rudder2   | Aileron4       | Aileron4  |  |
| 5      | Gear     | AUX7     | Gear           | AUX6      | Gear           | AUX6      | Flap           | Flap      | Rudder         | Rudder    |  |
| 6      | Aileron2 | Aileron2 | Flap           | Flap      | Flap           | Flap      | Flap2          | Flap2     | Rudder2        | Rudder2   |  |
| 7      | VPP      | AUX6     | Aileron2       | Aileron2  | Aileron2       | Aileron2  | Flap3          | Flap3     | Flap           | Flap      |  |
| 8      | AUX5     | AUX5     | VPP            | AUX5      | Flap2          | Flap2     | Flap4          | Flap4     | Flap2          | Flap2     |  |
| 9      | Elevator | Elevator | Elevator       | Elevator  | Elevator       | Elevator  | Elevator       | Elevator  | Elevator       | Elevator  |  |
| 10     | Camber   | Camber   | Camber         | Camber    | Camber         | Camber    | Camber         | Camber    | Camber         | Camber    |  |
| 11     | AUX1     | AUX1     | AUX1           | Butterfly | VPP            | Butterfly | Gear           | Butterfly | Gear           | Butterfly |  |
| 12     | AUX1     | AUX1     | AUX1           | AUX1      | AUX1           | AUX1      | Throttle       | Motor     | Throttle       | Motor     |  |
| DG1    | SW       | SW       | SW             | SW        | SW             | SW        | SW             | SW        | SW             | SW        |  |
| DG2    | SW       | SW       | SW             | SW        | SW             | SW        | SW             | SW        | SW             | SW        |  |

\* Output channels differ by each system of a table. When using a system with few channels, there is a wing type which cannot be used. It cannot be used when there is a function required out of the range of the arrow of a figure.

● FASSTest14CH/FASST MULTI/FASST 7CH/S-FHSS

| CH  | All Other | H-4, H4X Swash |
|-----|-----------|----------------|
| 1   | Aileron   | Aileron        |
| 2   | Elevator  | Elevator       |
| 3   | Throttle  | Throttle       |
| 4   | Rudder    | Rudder         |
| 5   | Gyro/RUD  | Gyro/RUD       |
| 6   | Pitch     | Pitch          |
| 7   | Governor  | Governor       |
| 8   | Needle    | Elevator2      |
| 9   | Gyro2/AIL | Gyro2/AIL      |
| 10  | Gyro3/ELE | Gyro3/ELE      |
| 11  | AUX1      | AUX1           |
| 12  | AUX1      | AUX1           |
| DG1 | SW        | SW             |
| DG2 | SW        | SW             |

The output CH of each system  
 FASSTest 14CH S-FHSS FASST MULTI  
 FASST 7CH

● FASSTest12CH

| CH  | All Other  | H-4, H4X Swash |
|-----|------------|----------------|
| 1   | Aileron    | Aileron        |
| 2   | Elevator   | Elevator       |
| 3   | Throttle   | Throttle       |
| 4   | Rudder     | Elevator2      |
| 5   | Pitch      | Pitch          |
| 6   | Gyro/RUD   | Gyro/RUD       |
| 7   | Governor   | Governor       |
| 8   | Governor 2 | Rudder         |
| 9   | Gyro2/AIL  | Gyro2/AIL      |
| 10  | Gyro3/ELE  | Gyro3/ELE      |
| DG1 | SW         | SW             |
| DG2 | SW         | SW             |

The output CH of each system  
 FASSTest 12CH

- Since the ch8 doesn't work on the 7-ch mode, please assign the elevator2 (H-4, H4X) or the needle (all other) to 7 channel if the governor is not used.

# MODEL BASIC SETTING PROCEDURE

## Airplane/glider basic setting procedure

### 1. Model addition and selection

Initially, the T14SG assigns the first model to model-01 in the transmitter. The Model Select function of the Linkage Menu is used to add models and to select amongst models which are already set.

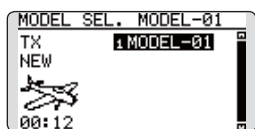

The T14SG is capable of storing data for up to 30 models in its internal memory. Additional model data can also be saved to an optional SD card.

The currently selected model name is displayed in the center of the home screen. Before flying and before changing any settings, always confirm the model name.

When a new model is added, the Model type select screen and System mode setup screen automatically appear. Please be aware that the transmitter will stop transmitting temporarily when you change the model.

When a new model is added, you will need to re-link the receiver.

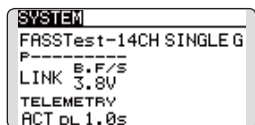
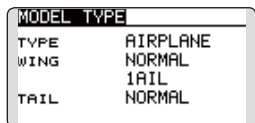

### 2. Model type selection

Select the model type matched to the aircraft with the Model Type select function of the Linkage Menu. For an airplane, select the model type from among the 2 types: airplane and glider. And then select the wing type and the tail type matched to the aircraft.

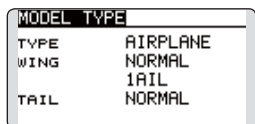

### 3. Fuselage linkage

Connect the ailerons, elevators, throttle, rudder, etc. in accordance with the model's instruction manual. For a description of the connection method, see the Receiver and Servos Connection.

**Note that even for the same "airplane model", when the wing type and tail type are different, the channel assignment may be different. (The channel assigned to each function can be checked at the Function menu of the Linkage Menu.)**

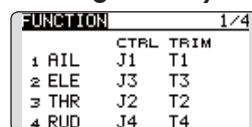

- If the direction of the servo is incorrect, adjust the direction with the Reverse function of the Linkage Menu.

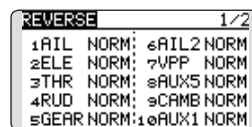

- Adjust the neutral position and control surface angle with the linkage, and fine tune them with the Sub-Trim and End Point functions (angle adjustment). To protect the linkage, a limit position can also be set with the End Point function. The End Point function can adjust the amount of up/down and left/right movement and limit of each channel.

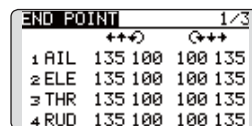
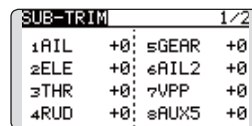

### 4. Throttle cut setting (Airplane)

Throttle cut can be performed with one touch by a switch without changing the throttle trim position.

Set throttle cut with the Throttle Cut function of the Linkage Menu. After activating the throttle cut function and selecting the switch, adjust the throttle position so that the carburetor becomes fully closed. For safety, the throttle cut function operates the

throttle stick in the 1/3 or less (slow side) position.

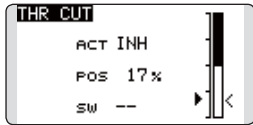

### 5. Idle down setting (Airplane)

The idling speed can be lowered with one touch by a switch without changing the throttle trim position. Perform this setting with the Idle Down function of the Linkage Menu. After activating the Idle Down function and selecting the switch, adjust the idle down speed. For safety, the idle down function acts only when the throttle stick is in the lowest part of its throw.

\*While the Throttle Cut function is in operation, the Idle Down function does not work.

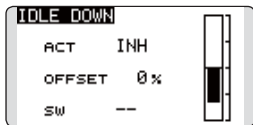

### 6. D/R function

D/R function is used to adjust the throw and operation curve of the stick functions (aileron, elevator, rudder and throttle) for each switch position (airplane) or each flight condition (glider). This is normally used after the modeler has defined the maximum throw directions in the End Point settings.

(Airplane)

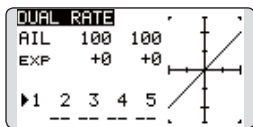

(Glider)

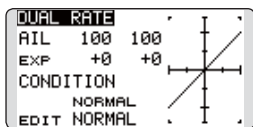

### 7. Airbrake (Airplane)

This function is used when an airbrake is necessary when taking off or diving, etc. Please note: this menu item is only available under certain wing configurations. For example, it will not appear if a single aileron wing type has been selected.

The pre-set elevator and flap offset amount can be activated by a switch.

The offset amount of the aileron, elevator, and flap servos can be adjusted as needed. Also the speed of the aileron, elevator, and flap servos can be adjusted. You can also set the Auto Mode, which will link Airbrake to a stick, switch, or dial. A separate stick switch or dial can also be set as the ON/OFF switch.

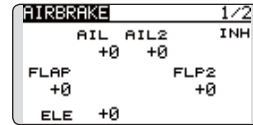

### 8. Addition of flight conditions (Glider)

The Condition Select function automatically allocates the normal condition (NORMAL) for each model. NORMAL is the default condition and is the only one active when a new model type is defined.

If you want to add flight conditions, please refer to a description of the CONDITION function.

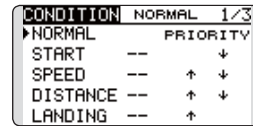

\*The NORMAL is always on, and remains on until other conditions are activated by switches, stick positions, etc. Please refer to the section entitled Switch Selection Method for additional information on how to do so.

\*It is possible to customize the activation of the flight conditions.

\*The Condition Delay can be programmed for each channel. The Condition Delay is used to change the servo throw smoothly when switching conditions.

---

## Helicopter basic setting procedure

This section outlines examples of use of the helicopter functions of the T14SG. Adjust the actual values, etc. to match the fuselage used.

### 1. Model addition and selection

Initially, the T14SG assigns the first model to model-01 in the transmitter. To add new models or to select a model already programmed, use the Model Select function of the Linkage Menu.

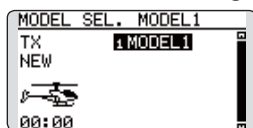

This is convenient when selecting a model after entering the model's names in advance. The T14SG is capable of storing up to 30 models in the transmitter's internal memory. Additional models can also be stored in an optional SD card.

The currently selected model is displayed in the middle of the screen. Before flying and before changing any settings, always confirm the model name.

When a new model is added, the Model Type select screen and system mode setup screen automatically appear. Change, or check that they match the swash type and receiver type of the model used.

When a new model is added, you will need to re-link the receiver.

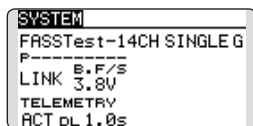
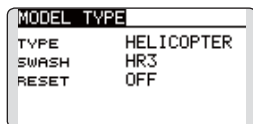

### 2. Model type and swash type selection

If a different model type is already selected, select helicopter with the Model Type function of the Linkage Menu, and then select the swash type matched to the helicopter.

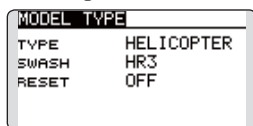

\*The Model Type function automatically selects the appropriate output channels, control functions, and mixing

functions for the chosen model type. Six swash types are available for helicopters.

\*For a description of the swash type selection, refer to the MODEL TYPE function.

### 3. Flight condition addition

The transmitter offers up to five flight conditions per model.

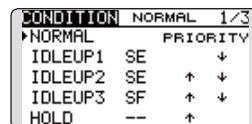

The Condition Select function automatically allocates five conditions for helicopters.

(Initial setting)

- NORMAL
- IDLE UP1 (SW-E)
- IDLE UP2 (SW-E)
- IDLE UP3 (SW-F)
- HOLD (Hold switch is not assigned initially)

**Note:** Since you may accidentally activate a condition that not previously setup during flight which could cause a crash, we suggest deleting conditions that are not used.

\*For a description of the condition deletion, refer to the Condition Select function.

The NORMAL condition is always on, and remains on until other conditions are activated by switches.

The priority is throttle hold/idle up 3/idle up 2/idle up 1/normal. Throttle hold has the highest priority.

The Condition Delay can be programmed for each channel and condition. The Condition Delay is used to change the servo throw smoothly when switching conditions.

#### (General flight condition setting example)

- Normal: (Use initial setting conditions/operate when switch OFF)  
Use from engine starting to hovering.
- Idle up 1: (Operate at SW-E center)  
Use in stall turn, loop, and other maneuvers.
- Idle up 2: (Operate at SW-E forward side)  
Use in rolls.
- Throttle hold: (Operate at SW-G forward side)  
Use in auto rotation.

## 4. Servo Connection

Connect the throttle rudder, aileron, elevator, pitch, and other servos in accordance with the kit instruction manual. For a description of the connection method, see "Receiver and Servos Connection".

**Note: The channel assigned to each function can be checked at the Function menu of the Linkage Menu.**

| FUNCTION | NORMAL | 1/4      |
|----------|--------|----------|
|          | CTAL   | TRIM     |
| 1 AIL    | J1     | T1 SEPAR |
| 2 ELE    | J3     | T3 SEPAR |
| 3 THR    | J2     | T2 SEPAR |
| 4 RUD    | J4     | T4 SEPAR |

- If the direction of operation of the servo is incorrect, use the Reverse function of the Linkage Menu. Also use the swash AFR function in other than the H-1 mode.

| THR CURVE      | NORMAL | 1/3 |
|----------------|--------|-----|
| EDITNORMAL     | COPY   |     |
| >5 100.0 (100) |        |     |
| >4 75.0 75.0   |        |     |
| >3 50.0 50.0   |        |     |
| >2 25.0 25.0   |        |     |
| >1 0.0 ( 0 )   |        |     |

| SWASH   | 1/5      |
|---------|----------|
| NEUTRAL | AFR      |
| Pos 50% | AIL +50% |
|         | ELE +50% |
|         | PIT +50% |

- Adjust the direction of operation of the gyro. (Gyro side function)
- Connect the throttle linkage so that the carburetor can fully close at full trim throttle cut.
- Adjust the neutral position at the linkage side and fine tune with the Sub-Trim function and End Point function. To protect the linkage, a limit position can also be set with the End Point function.

| SUB-TRIM          | 1/2 |
|-------------------|-----|
| 1AIL +0; 5GYRO +0 |     |
| 2ELE +0; 6PIT +0  |     |
| 3THR +0; 7GOV +0  |     |
| 4RUD +0; 8NDL +0  |     |

| END POINT             | 1/3     |
|-----------------------|---------|
|                       | ↔↔↔ ↔↔↔ |
| 1 AIL 135 100 100 135 |         |
| 2 ELE 135 100 100 135 |         |
| 3 THR 135 100 100 135 |         |
| 4 RUD 135 100 100 135 |         |

- Swash plate correction (Except H-1 mode)  
\*If any interactions are noticed, for a description of the linkage correction function, please refer to the SWASH function.

## 5. Throttle/Pitch curve setting

This function adjusts the throttle or pitch operation curve in relation to the movement of the throttle stick for each condition.

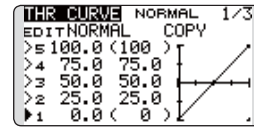

### <Throttle curve setting example>

Activate the throttle curve of each condition with the condition select switch.

- Normal curve adjustment  
Normal curve creates a basic throttle curve centered near hovering. This curve is adjusted together with the pitch curve (Normal) so that the engine speed is constant and up/down control is easiest.
- Idle up curve adjustment  
The low side Throttle curve creates a curve matched for aerobatics (loop, roll, 3D, etc.).
- Throttle hold curve adjustment  
Confirm that the rate of the slowest position (0%) of the stick is 0% (initial setting).

### <Example of pitch curve setting>

Activate the pitch curve of each condition with the condition select switch.

- Pitch curve (Normal)  
Make the pitch at hovering approximately +5°~6°. Set the pitch at hovering with the stick position at the 50% point as the standard.  
\*Stability at hovering may be connected to the throttle curve. Adjustment is easy by using the hovering throttle function and hovering pitch function together.

- Pitch curve (Idle up 1)  
The idle up 1 pitch curve function creates a curve matched to airborne flight. Set to -7°~+12° as standard.
- Pitch curve (Idle up 2)  
The high side pitch setting is less than idle up 1. The standard is +8°.
- Pitch curve (Hold)  
At auto rotation, use the maximum pitch at both the high and low sides.  
[Pitch angle setting example]  
Throttle hold: -7°~+12°



## 6. D/R function

D/R function is used to adjust the throw and operation curve of aileron, elevator and rudder for each condition.

\*For throttle and pitch curve settings, refer to the aforementioned "Throttle/Pitch curve setting"

This is normally used after End Point has defined the maximum throw directions.

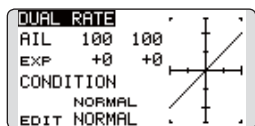

## 7. Gyro sensitivity and mode switching

The gyro sensitivity and mode switching function is utilized to adjust the gyro mixing of the model, and can be set for each condition.

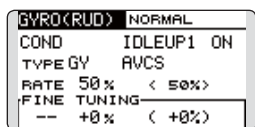

- Normal condition (hovering): Gyro sensitivity maximum
- Idle up 1/Idle up 2/Throttle hold: Gyro sensitivity minimum
- However, during auto rotations with a tail-driven helicopter, this function may not have any effect on the high gyro sensitivity.

## 8. Pitch to RUD mixing setting

**Note: When using a Futaba GY Gyro, or other heading hold gyro, this Pitch to RUD mixing should not be used. The reaction torque is corrected by the gyro. When operating the gyro in the AVCS mode, the mixed signal will cause neutral deviation symptoms and the gyro will not operate normally.**

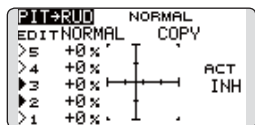

Use this function when you want to suppress the torque generated by the changes in the pitch and speed of the main rotor during pitch operation. Adjust it so that the nose does not swing in the rudder direction. However, when using a heading hold gyro like those shown above, do not use Pitch to rudder mixing.

Activate the Pitch to rudder (Pit -->RUD) mixing

function from the Model Menu, and set the curve for each condition. (At initial setting, this function is in the "INH" state. To use it, set it to the "ON" state.)

### <Setting example>

Activate the mixing curve of each condition with the condition select switch.

A curve setting example is shown below.

- Pitch to RUD mixing curve (Normal)  
Use the hovering system and set this curve to match take off and landing and vertical climb at a constant speed.
- Pitch to RUD mixing (Idle up 1)  
Use this curve in stall turn, loop, and adjust it so the fuselage is facing straight ahead when heading into the wind.
- Pitch to RUD mixing (Hold)  
This function is set so that the fuselage is facing straight ahead at straight line auto rotation. The pitch of the tail rotor becomes nearly 0°.

## 9. Throttle hold setting

\*If throttle hold is necessary, please refer to the THR HOLD function.

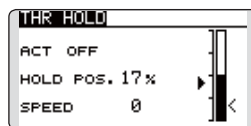

## 10. Throttle cut setting

Throttle cut provides an easy way to stop the engine, by flipping a switch with the throttle stick at idle. The action is not functional at high throttle to avoid accidental dead sticks. The switch's location and direction must be chosen, as it defaults to NULL.

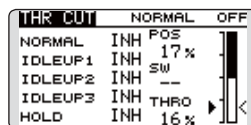

\*With throttle stick at idle, adjust the cut position until the engine consistently shuts off, but throttle linkage is not binding.

## 11. Swash Mix corrects aileron, elevator and pitch interaction

The swash mix function is used to correct the swash plate in the aileron (Left/Right Cyclic) and elevator (Forward/Aft Cyclic) direction corresponding to each operation of each condition.

| SWASH MIX NORMAL 1/2 |       |       |
|----------------------|-------|-------|
| EDIT                 |       |       |
| NORMAL               | RATE1 | RATE2 |
| AIL→ELE              | +0%   | +0%   |
| ELE→AIL              | +0%   | +0%   |
| PIT→AIL              | +0%   | +0%   |
| PIT→ELE              | +0%   | +0%   |

## 12. Throttle mixing setting

\*If throttle mixing is necessary for a compensation for slowing of engine speed caused by swash plate operation during aileron or elevator operation, please refer to the THROTTLE MIX function.

| THR MIX NORMAL 1/2 |       |       |
|--------------------|-------|-------|
| EDIT               |       |       |
| NORMAL             | RATE1 | RATE2 |
| AIL→THR            | +0%   | +0%   |
| ELE→THR            | +0%   | +0%   |
| RUD→THR            | +0%   | +0%   |

## 13. Other special mixings

- Pitch to Needle mixing

This mixing is used with engines with a design which allows needle control during flight (fuel-air mixture adjustment). A needle curve can be set.

- Governor mixing

This mixing is dedicated governor mixing when a governor is used.

---

# SYSTEM MENU

The System Menu sets up functions of the transmitter: This does not set up any model data.

- Call the system menu shown below by touching the SYS button twice at the home screen, etc.

- Select [SYSTEM MENU] and return to the home screen by touching the RTN button. Or a HOME/EXIT button is pushed.

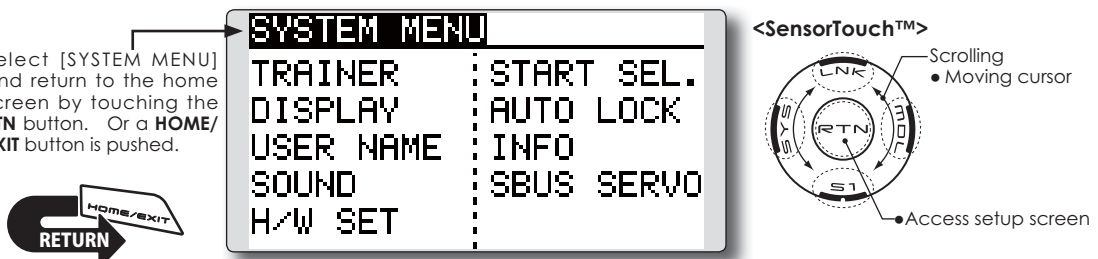

The diagram shows a central LCD screen displaying the 'SYSTEM MENU' with the following options: TRAINER, DISPLAY, USER NAME, SOUND, H/W SET, START SEL., AUTO LOCK, INFO, SBUS SERVO. To the left, a 'HOME/EXIT RETURN' button is shown with an arrow pointing to the screen. To the right, a circular touch sensor layout is shown with buttons labeled LNK, SYS, RTN, and S1. Arrows indicate scrolling and a moving cursor, and a dot indicates the location to access the setup screen.

- Select the function you want to set and call the setup screen by touching the RTN button.

---

## System Menu functions table

- [TRAINER]: Starts and sets the trainer system.
- [DISPLAY]: LCD and back-light adjustment
- [USER NAME]: User name registration
- [SOUND]: Turns off the buzzer.
- [H/W SET]: H/W reverse, calibration and stick mode
- [START SEL.]: Immediately, a model selection can be performed
- [AUTO LOCK]: The automatic lock function of two kinds of touch sensors
- [INFO]: Displays the program version, SD card information, product ID, and language selection.
- [SBUS SERVO]: S.BUS servo setting.

T14SG trainer system makes it possible for the instructor to choose which channels and operation modes that can be used in the student's transmitter. The function and rate of each channel can be set, the training method can also be matched to the student's skill level. Two transmitters must be connected by an optional Trainer Cord, and the Instructor's transmitter should be programmed for trainer operation, as described below.

When the Instructor activates the trainer switch, the student has control of the aircraft (if MIX/FUNC/NORM mode is turned on, the Instructor can make corrections while the student has control). When the switch is released the Instructor regains control. This is very useful if the student gets the aircraft into an undesirable situation.

- Setting data are stored to model data.
- Student rate can be adjusted at MIX/FUNC/NORM mode.
- Activated student channels can be selected by switches.

**NOTE: This trainer system can be used in the following manner;**

1. With the T14SG transmitter and a conventional transmitter, if the channel order is different, it is necessary to match the channel order before using this function.

You can select the channel of input data from student's transmitter in the "FUNC" or "MIX" mode.

2. When the T14SG is used as the instructor's transmitter, set the modulation mode of the student's transmitter to PPM.

If being used as the student, T14SG can be connected to the instructor's transmitter which the PPM mode as the student's modulation mode is required. T14SG always sends PPM mode signal from the trainer jack.

3. Be sure that all channels work correctly in both transmitters before flying.

### Corresponding types of transmitters and trainer mode settings:

| Types of transmitters                  |  | Instructor's transmitter settings |                            | Student's transmitter settings |                            |           | Trainer Cords  |
|--|--|-----------------------------------|----------------------------|--------------------------------|----------------------------|-----------|--|
| Instructor                             | Student                                | System Type<br>Mod. mode          | Trainer setting<br>CH mode | System Type<br>Mod. mode       | Trainer setting<br>CH mode | Mod. mode |  |
| T14SG/T18MZ                            | T14SG/T18MZ                            | Arbitrary                         | 14CH/16CH                  | Arbitrary                      | 14CH/16CH                  | -         | T12FG (FUTM4405)<br>and 9C (FUTM4415)<br>Trainer Cords |
| T14SG                                  | T14MZ, FX-40,<br>T12Z, T12FG,<br>FX-30 | Arbitrary                         | 12CH                       | PCM-G3<br>2.4G                 | 12CH                       | PPM       |  |
| T14SG                                  | T8FG, FX-20                            | Arbitrary                         | 12CH<br>8CH                | FASST-MLT2<br>FASST-MULT       | -                          | -         | T12FG (FUTM4405)                                       |
| T14SG                                  | T10C, T9C,<br>T7C, T6EX,<br>T4EX       | Arbitrary                         | 8CH                        | PPM                            | -                          | -         |  |
| T14SG                                  | T10CG, T7C                             | Arbitrary                         | 8CH                        | Arbitrary                      | -                          | -         | T12FG (FUTM4405)                                       |
| T14SG                                  | T8J, T6J                               | Arbitrary                         | 8CH                        | Arbitrary                      | -                          | -         | T12FG (FUTM4405)<br>and 9C (FUTM4415)<br>Trainer Cords |
| T14MZ, FX-40,<br>T12Z, T12FG,<br>FX-30 | T14SG                                  | Arbitrary                         | 12CH                       | Arbitrary                      | 12CH                       | -         |  |
| T8FG, FX-20                            | T14SG                                  | Arbitrary                         | 12CH                       | Arbitrary                      | 12CH                       | -         |  |
| T10C, T10CG,<br>T9C, T7C,<br>T7C, T8J  | T14SG                                  | Arbitrary                         | -                          | Arbitrary                      | 8CH                        | -         |  |

- Select [TRAINER] in the System menu and enter the setup screen shown below by touching the RTN button.

• Select the function name and return to the System menu by touching the RTN button. Or the HOME/EXIT button is pushed.

**TRAINER 1/4**

| INH | MODE | RATE | STU. | CH |
|-----|------|------|------|----|
| 1   | AIL  | OFF  |      |    |
| 2   | ELE  | OFF  |      |    |
| 3   | THR  | OFF  |      |    |
| 4   | RUD  | OFF  |      |    |

**<SensorTouch™>**

- Scrolling
  - Moving cursor
  - Selecting mode
  - Adjusting value
- To next page

### Mode and switch selection

1. Access the setup screen page 4 shown below by touching the S1 button three times.

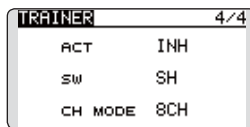

2. Move the cursor to the [ACT] or [12/8CH] item and touch the RTN button to switch to the data input mode.
3. Select the mode by scrolling the touch sensor. The display blinks. Touch the RTN button to change the mode. (To terminate the mode change, touch the S1 button.)

"ACT": Enable operation by changing to [OFF] or [ON].

"12/8 CH": When the student uses the T14SG, T14MZ, T12Z, T12FG or FX-40, select [12CH]. Otherwise select [8CH].

If changing the trainer switch:

4. Move the cursor to the [SW] item and touch the RTN button to access the switch setup screen.

(See "Switch selection method" at the end of this manual for selection method details.)

"SW": Select the desired switch.

Initial setting: SH

\*The switch mode can also be selected when setting the ON position on the switch setup screen. When [ALTERNATE OFF] is selected, normal ON/OFF operation is performed. When [ALTERNATE ON] is selected, the trainer function is alternately turned on and off each time the switch is operated. This allows alternate ON/OFF switching even when a momentary switch (SH) is used.

**Note: The trainer function won't be turned on unless the Instructor's transmitter receives signals from the student's transmitter. Be sure to confirm this after connecting your trainer cable.**

### Operating mode selection

(Setup screen page 1-3)

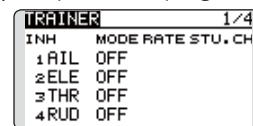

1. Move the cursor to the [MODE] item of the channel you want to change and touch the RTN button to switch to the data input mode.
2. Select the mode by scrolling the touch sensor. The display blinks. Touch the RTN button to change the mode. (To terminate the mode change, touch the S1 button.)

"MODE": Select the desired operation mode for each channel.

NORM: The model is controlled by signals from the student transmitter.

MIX mode: The model is controlled by signals from the instructor and student transmitters. (Reset the student's model data to the default condition.)

FUNC mode (function mode): The model is controlled by signals from the student transmitter with the instructor's setting. (Reset the student's model data to the default condition.)

OFF: Only the instructor side operates.

### Adjusting the student's rate.

\*This can be adjusted for students who may need lower rates than a more experienced student.

- 
1. Move the cursor to the [RATE] item of the channel you want to change and touch the RTN button to switch to the data input mode.
  2. Adjust the rate by scrolling the touch sensor.

"RATE": Adjust the desired rate.

Setting range: 0~100%

Initial value: 100%

\*When you want to reset the value to the initial state, touch the RTN button for one second.

3. To end adjustment, touch the RTN button and return to the cursor mode.

### **Changing the student's channel**

---

\*The setting above allows setting of the channel assignment of student side when [MIX] or [FUNC] was selected.

1. Move the cursor to the [STU. CH] item of the channel you want to change and touch the RTN button to switch to the data input mode.
2. Select the channel by scrolling the touch sensor. The display blinks. Touch the RTN button to change the channel. (To terminate the mode change, touch the S1 button.)

"STU. CH": Match the channel order of the Instructor's and student's transmitter. This function will help if both transmitters are in different modes, or the Master has a different wing type set up. The student can be set to match the Master without any physical changes being made.

LCD contrast, back-light brightness and back-light off-timer adjustment are possible:

Moreover, a display unit can be chosen from the metric system or yard/pound.

- Select [DISPLAY] at the system menu and access the setup screen shown below by touching the RTN button.

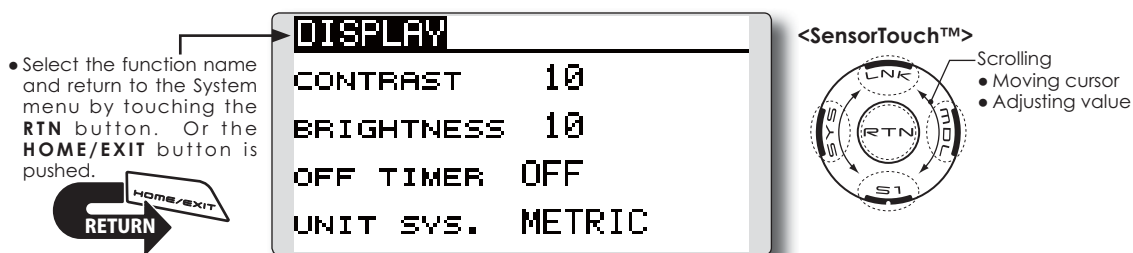

### LCD contrast adjustment

1. Select "CONTRAST" and touch the RTN button to switch to the data input mode and adjust the contrast by scrolling the touch sensor.

"CONTRAST": Adjust the contrast to the desired value while watching the screen display.

Setting range: (Lighter) 0 to 15 (Darker)

Initial value: 5

\*When you want to reset the value to the initial state, touch the RTN button for one second.

2. Touch the RTN button to end adjustment and return to the cursor mode.

### Back-light brightness adjustment

1. Select "BRIGHTNESS" and touch the RTN button to switch to the data input mode and adjust the back-light brightness by scrolling the touch sensor.

"BRIGHTNESS": Adjust the brightness to the desired value while watching the screen display.

Setting range: OFF, 1 to 20(Lighter)

Initial value: 10

\*When you want to reset the value to the initial state, touch the RTN button for one second.

2. Touch the RTN button to end adjustment and return to the cursor mode.

### Back-light off-timer

1. Select "OFF TIMER" and touch the RTN button to switch to the data input mode and adjust the back-light off-timer by scrolling the touch sensor.

"OFF TIMER": Adjust the time when the back-light turns off after operating the touch sensor.

Setting range: 10 to 240 sec (each 10 sec), OFF (always on)

Initial value: 10 sec

\*When you want to reset the value to the initial state, touch the RTN button for one second.

2. Touch the RTN button to end adjustment and return to the cursor mode.

### Unit system adjustment

1. Select "UNIT SYS." and touch the RTN button to switch to the data input mode and adjust the unit by scrolling the touch sensor.

Setting range: (METRIC) or (YARD/POUND)

2. Touch the RTN button to end adjustment and return to the cursor mode.

# USER NAME

## User name registration

This function allows the modelers to change the T14SG user name.

\*A name of up to 10 characters can be entered as the user name. Please note that a space is also counted as one character.

- Select [USER NAME] at the System menu and access the setup screen shown below by touching the RTN button.

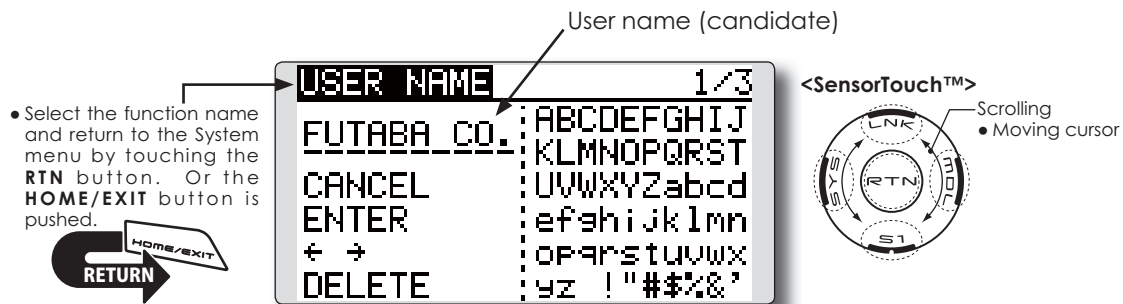

### User name registration

1. Change the user name as described below:

[Moving cursor in user name (candidate)]  
Select [←] or [→], and touch the RTN button.

[Deleting a character]

When [DELETE] is selected and the RTN button is touched, the character immediately after the cursor is deleted.

[Adding a character]

When a character is selected from the character list and the RTN button is touched, that character is added at the position immediately after the cursor.

\*A name of up to 10 characters long can be entered as the user name. (A space is also counted as 1 character.)

2. Upon completing the input, select [ENTER] and touch the RTN button. (To terminate input and return to the original state, select [CANCEL] and touch the RTN button.)

(Character list 1/3)

|            |            |
|------------|------------|
| USER NAME  | 1/3        |
| FUTABA_CO. | ABCDEFGHIJ |
| CANCEL     | KLMNOPQRST |
| ENTER      | UVWXYZabcd |
| ← →        | efghijklmn |
| DELETE     | oprstuvwxy |
|            | z !"#\$%&' |

(Character list 2/3)

|            |            |
|------------|------------|
| USER NAME  | 2/3        |
| FUTABA_CO. | 0123456789 |
| CANCEL     | .,:;+*!~   |
| ENTER      | <>=?@[]^_  |
| ← →        | ¥90éääää9  |
| DELETE     | éééii11AAé |
|            | fé0000900B |

(Character list 3/3)

|            |           |
|------------|-----------|
| USER NAME  | 3/3       |
| FUTABA_CO. | アイエオカキクコ  |
| CANCEL     | サシセソチチチ   |
| ENTER      | ナニネノヒフヘホ  |
| ← →        | マミムメフ 1 3 |
| DELETE     | ラリルロカク    |
|            | アイエオカキク   |



## SOUND

Turns off the buzzer.

The warning sound and other sounds of the T14SG transmitter can be turned off.

\*When "WARNING" was set to OFF, the no operation alarm (30 minutes), mixing warning sound, and low battery alarm sounds also turned off.

- Select [SOUND] at the system menu and access the setup screen shown below by touching the RTN button.

• Select the function name and return to the System menu by touching the RTN button. Or the HOME/EXIT button is pushed.

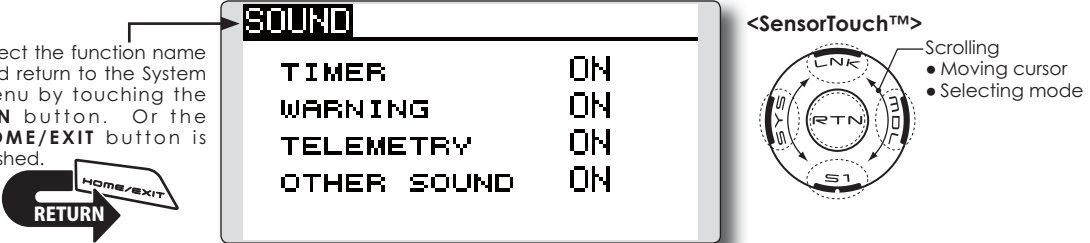

The diagram shows a rectangular screen with a title bar labeled "SOUND". Below the title bar, there is a list of four items, each with a status indicator:

|             |    |
|-------------|----|
| TIMER       | ON |
| WARNING     | ON |
| TELEMETRY   | ON |
| OTHER SOUND | ON |

To the left of the screen, there are two arrows: a curved arrow labeled "RETURN" and a straight arrow labeled "HOME/EXIT".

To the right of the screen, there is a circular control knob labeled "<SensorTouch™>". The knob has several segments labeled "LNK", "RTN", "S1", and "SYS". A legend to the right of the knob explains its functions:

- Scrolling
- Moving cursor
- Selecting mode

### On/off operation

1. Move the cursor to the [TIMER][WARNING] or [OTHER SOUND] item and touch the RTN button to switch to the data input mode.
2. Select the ON or OFF by scrolling the touch sensor.

\*The display blinks.

3. Touch the RTN button.

## H/W reverse

This function reverses the operation direction of the sticks, switches, trimmer levers, and knobs.

**Note:** This setting reverses the actual operation signal, but does not change the display indicators. Use the Normal mode as long as there is no special reason to use the Reverse mode.

## Stick mode

This function changes the stick mode of transmitter.

**Note:** This will not change the throttle ratchet, etc. Those are mechanical changes that must be performed by a Futaba service center.

**Note:** After changing the mode, these changes are only applied to new models. It is not applied to an existing model.

## Stick calibration

J1-J4 stick correction can be performed.

- Select [H/W SET] at the system menu and access the setup screen shown below by touching the RTN button.

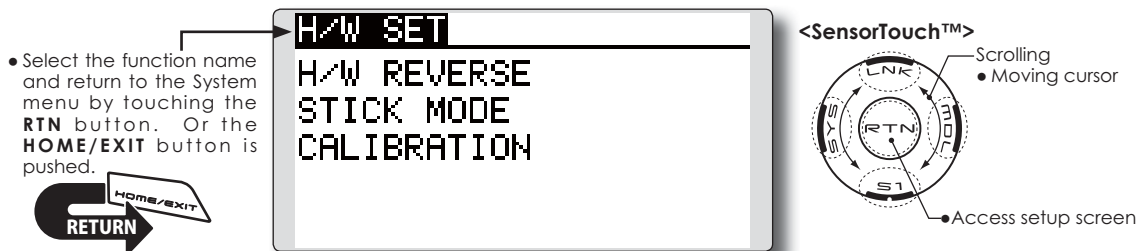

## Operation direction reversal method

1. Select [H/W REVERSE] and access the setup screen shown below by touching the RTN button.

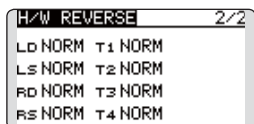
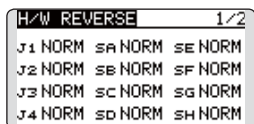

2. Move the cursor to the item corresponding to the H/W (hardware) you want to reverse and touch the RTN button to switch to the data input mode.
3. Select the mode by scrolling the touch sensor. The display blinks. When the RTN button is touched, the operation direction is reversed. (To terminate the mode change, touch the S1 button.)

"NORM": Normal operation direction

"REV" : Operation direction is reversed.

## Changing stick mode

1. Select [STICK MODE] and access the setup screen shown below by touching the RTN button.



2. Move the cursor to the "STICK MODE" item and touch the RTN button to switch to the data input mode.
3. Select the mode. The display blinks. When the RTN button is touched, the stick mode is changed. (To terminate the mode change, touch the S1 button.)

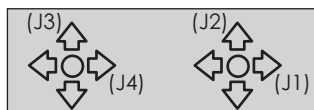

| Mode | J1      | J2       | J3       | J4      |
|------|---------|----------|----------|---------|
| 1    | Aileron | Throttle | Elevator | Rudder  |
| 2    | Aileron | Elevator | Throttle | Rudder  |
| 3    | Rudder  | Throttle | Elevator | Aileron |
| 4    | Rudder  | Elevator | Throttle | Aileron |

---

## Stick calibration method

\*J3 and J4 correction is described below. J1 and J2 corrections are performed using the same procedure.

1. Select [CALIBRATION] and access the setup screen shown below by touching the RTN button.

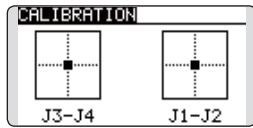

2. Move the cursor to the J3-J4 button and touch the RTN button.

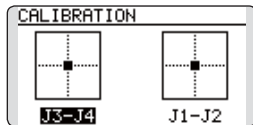

3. Move the J3 or J4 sticks to the neutral position and press the RTN button for one second.

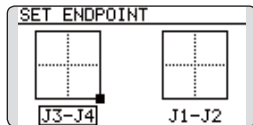

4. Set the J3 and J4 sticks fully to the bottom right and wait until the buzzer sounds.

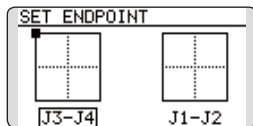

5. Set the J3 and J4 sticks fully to the top left and wait until the buzzer sounds.

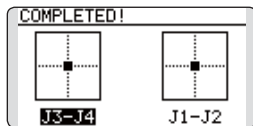

6. The above completes the correction operation. Operate and check if stick correction was performed normally.

# START SEL.

Immediately, a model selection can be performed

START SEL is a function which starts and can perform a model selection immediately.

Each time, it is convenient for the modeler which is enjoying two or more models by one of a transmitter.

## Quick Select Screen

As the name suggests, the Quick Model Select Function enables the modeler to change the selected models rapidly each time the transmitter is

turned ON. With a few quick touches, it is possible to change models whereas before it would require a multi-step process. The T14SG stores up to four models in the Quick Select offerings.

## Model Select Screen

When the transmitter is turned on, it will open to the Model Selection Screen immediately.



## Setting Up and Adjusting the Quick Select Models

1. The Start Selection (START SEL.) menu is accessed through the T14SG System Menu. Turn the transmitter ON and then press the SYS (System) button two times. Use the SensorTouch™ to highlight the Start Selection (START SEL.) and then press the Return (RTN) button to confirm the selection.

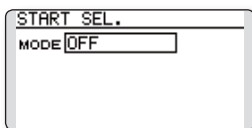

2. The Start Selection (START SEL.) menu option defaults to OFF meaning that Quick Select and Model Select are not applicable. To activate the Quick Select or Model Select, use the SensorTouch to scroll to the OFF setting as denoted in the image. With the OFF indication highlighted, press the Return (RTN) button and rotate the SensorTouch once again to scroll amongst the options. With the Quick Select (QUICK SEL.) indicated, press the Return (RTN) button once again to make the desired selection as indicated.

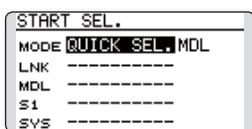

activated, there are two additional options available for customization; ALWAYS and MDL (Model). These options determine if/when the Quick Select information will appear on-screen. ALWAYS, as the name suggests, indicates that each time the transmitter is powered-up, the Quick Select information will appear on-screen. The MDL (Model) setting indicates that the Quick Select information will appear on-screen only when the MDL button is pressed simultaneously as the transmitter is turned ON. With the Quick Select mode highlighted, use the SensorTouch to move to the activation setting options. Model (MDL) is the default setting. Press the Return (RTN) button to bring forth the options, then scroll to the ALWAYS setting using the SensorTouch pad. Press the Return (RTN) button once again to finalize the selection.

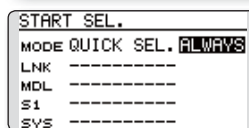
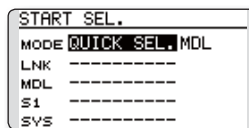

## Quick Select Activation:

With the Quick Select (QUICK SEL.) option

### Assigning models to the sensor buttons:

There are four sensors/buttons that correspond with the SensorTouch: Link (LNK), Model (MDL) System (SYS) and S1. As such, it is possible to offer up to four models available through the Quick Select function. We suggest using the models that you fly most often.

1. Use the SensorTouch, scroll to the desired sensor/button for the first model; for example, Link (LNK).
2. With the input next to the desired sensor highlighted, press the Return (RTN) button one time.
3. Using the SensorTouch, scroll through the available models. To select the desired model, press the Return (RTN) button.
4. Repeat as desired for the remaining sensors.

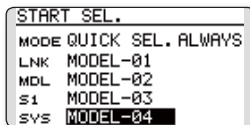

### Using the sensors to select the model:

1. Turn ON the transmitter, activating the Quick Select screen. If Model (MDL) has been selected, please be sure to press the Model (MDL) sensor when powering up the transmitter.

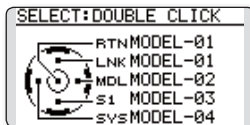

\*Please note: Even if the Quick Select function is active, the Power Mode screen will appear when the transmitter is turned ON while simultaneously pressing the Return (RTN) button.

2. To select the model assigned to a particular sensor, double-click the desired sensor. For example, MODEL- 03 is assigned to S1, double-click S1 to bring forth all settings, etc. for Model -03. The T14SG offers an audible and visual confirmation as the selected model memory is changed accordingly.

\*If the Return (RTN) button is double-clicked, the T14SG the current model is selected as indicated on the display. That is, the model that was used prior to the last time the transmitter was turned OFF.

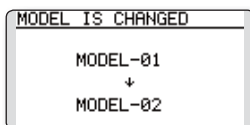

### Model Select Screen

This allows the Model Select screen to be accessed immediately upon turning ON the transmitter.

\*Please note: this function cannot be utilized at the same time as the Quick Select function. If more than four models are flown regularly, we suggest that the Model Select function be utilized as it will save time when selecting the desired aircraft. If four, or fewer, models are flown, the Quick Select option would be the best choice.

\*Please note: the Model Select function does not allow access to the RENAME, COPY or DELETE options. To utilize one of these options, please access the Model Select screen in the typical manner as described in the complete instruction manual.

1. The Start Selection (START SEL.) menu is accessed through the T14SG's System Menu. Turn the transmitter ON and then press the SYS (System) button two times. Use the SensorTouch™ to highlight the Start Selection (START SEL.) and then press the Return (RTN) button to confirm the selection.

2. The Start Selection (START SEL.) menu option defaults to OFF meaning that Quick Select and Model Select are not applicable. To activate the Quick Select or Model Select, use the SensorTouch to scroll to the OFF setting as denoted in the image. With the OFF indication highlighted, press the Return (RTN) button and rotate the SensorTouch once again to scroll to the Model Select (MODEL SEL.). Press the Return (RTN) button once again to activate Model Select as indicated.

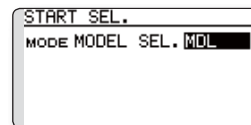

### Model Select Activation:

With the Model Select (MODEL SEL.) option activated, there are two additional options available for customization; ALWAYS and MDL (Model). These options determine if/when the Model Select information will appear on-screen. ALWAYS, as the name suggests, indicates that each time the transmitter is powered-up, the Model Select information will appear on-screen. The MDL (Model) setting indicates that the Model Select information will appear on-screen only when the MDL button is pressed simultaneously as the transmitter is turned ON.

With the Model Select mode highlighted, use the

SensorTouch to move to the activation setting options. Model (MDL) is the default setting. Press the Return (RTN) button to bring forth the options, then scroll to the ALWAYS setting using the SensorTouch pad. Press the Return (RTN) button once again to finalize the selection.

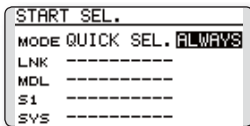
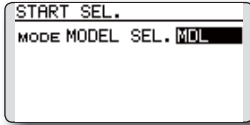

**Using the Model Select Function:**

1. Turn ON the transmitter, activating the Model Select screen. If Model (MDL) has been selected, please be sure to press the Model (MDL) sensor when powering up the transmitter.

\*Please note: Even if the Model Select function is active, the Power Mode screen will appear when the transmitter is turned ON while simultaneously pressing the Return (RTN) button.

2. The SensorTouch is used to select amongst the on-screen models. The current model will automatically be highlighted when the transmitter is turned ON. If a different model is desired, use the SensorTouch to scroll through the available options; each highlighted accordingly. Again, to select a model, press the Return (RTN) button accordingly. The T14SG offers an audible and visual confirmation as the selected model memory is changed.

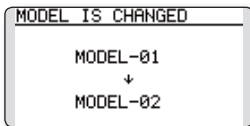
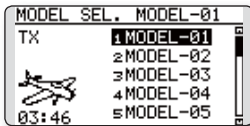

# AUTO LOCK

The automatic lock function of two kinds of SensorTouch

The Auto Lock function makes it possible to lock the transmitter to prevent any unwanted input from your hands while flying.

The auto lock function can be set in two ways.

## LOCK TIMER

Auto Lock functions automatically when there is no operation from the HOME screen display for a chosen number of seconds.

- Select the function name and return to the System menu by touching the RTN button. Or the HOME/EXIT button is pushed.

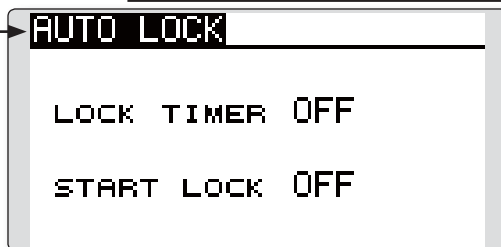

● **Manual lock**  
If **HOME/EXIT** button is touched **1** second or more from a **HOME** screen, a **SensorTouch** locks manually.

● **Manual lock**  
If **S1** button is touched **1** second or more from a **HOME** screen, a **SensorTouch** locks manually.

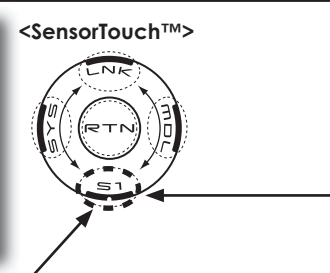

● **Lock release**  
Every lock function's touch [ **1** second or more ] of **S1** button will **release** the lock.

● **Lock release**  
Every lock function's touch [ **1** second or more ] of **HOME/EXIT** button will **release** the lock.

## Auto lock method

1. Open the Auto lock screen in the system menu.

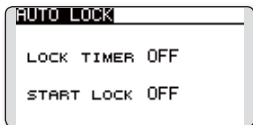

2. Adjust the activation timer for the Auto Lock function. The timer will begin counting immediately when the HOME screen is not used. The timer is adjustable in one second increments up to 30 seconds. If the timer value is OFF, this function is not applicable.

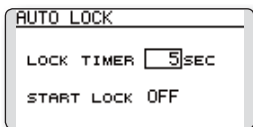

3. The Start Lock setting will, if enabled, automatically lock the T14SG when the transmitter is powered up. To allow access to the transmitter's functions, press and hold the S1 key for one second.

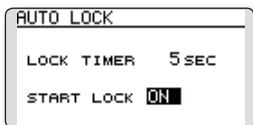

● **Display of a lock**  
If locked, there will be sound and the **icon of a key** will come out.

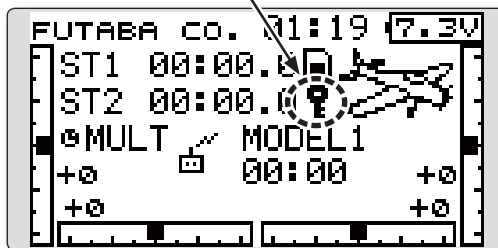

## ⚠ Danger

- ❗ It is recommended to Lock the SensorTouch during flight, to prevent any accidental touches which could change settings and cause an accident.

\*If neither the Lock Timer or Start Lock functions are active (OFF), then the key lock remains even if the power is turned off.

\*If the Lock Timer is enabled and the Start Lock is off, the key lock status is canceled each time the T14SG is turned on.

## INFO

Displays the program version, SD card information, and product ID.

The T14SG system program version information, SD card information (current and maximum number of model data and other files), and product ID are displayed on the Information screen.

The language displayed in home, menu, and setup screen is selectable.

\*When the SD card is not inserted, the SD card information is not displayed.

- Select [INFO] at the system menu and access the setup screen shown below by touching the RTN button.

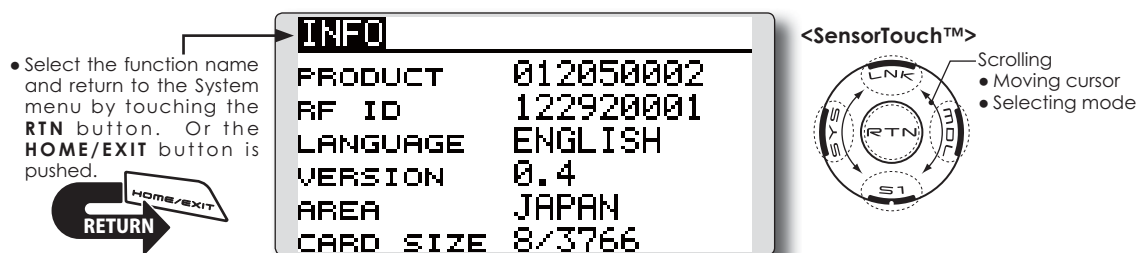

### Information

"PRODUCT": Product ID number

"RF ID": RF ID number

"LANGUAGE": The language used in T14SG

"VERSION": T14SG system program version information

"AREA": Area which can use T14SG

"CARD SIZE": Current/Maximum number of model data and other files (SD card)

### Language selection

1. Move the cursor to the "LANGUAGE" item and touch the RTN button to switch to the data input mode.
2. Change the language by scrolling the touch sensor. The display blinks. When the RTN button is touched, the language is changed. (To terminate the change, turn the EDIT dial or push the S1 button.)



An S.BUS servo can memorize the channel and various settings you input. Servo setting can be performed on the T14SG screen by wiring the servo as shown in the figure.

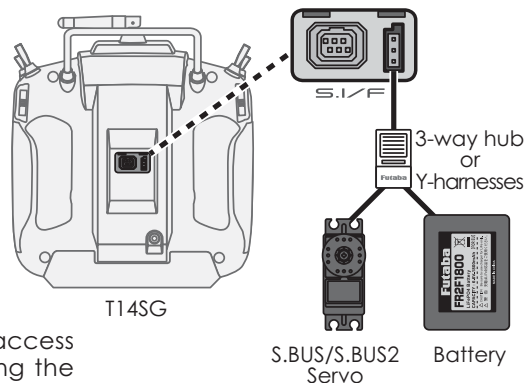

- Select [SOUND] at the system menu and access the setup screen shown below by touching the RTN button.

- Select the function name and return to the System menu by touching the RTN button. Or the HOME/EXIT button is pushed.

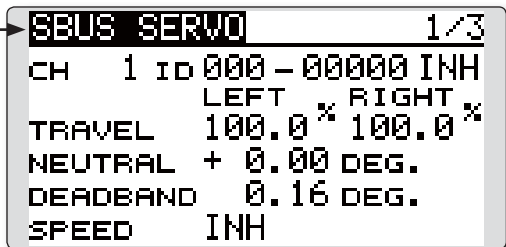

<SensorTouch™>

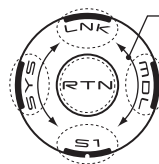

- Scrolling
- Moving cursor
- Selecting mode

## Servo ID number

Individual ID numbers are memorized for your S.BUS(2) servos in your T14SG. When a servo is used, the servo ID number is automatically read by the transmitter. If you use multiple S.BUS(2) servos and do not want to change the settings on all that are mounted in a fuselage, only the desired servo in the group can be set by entering the ID of that specific servo.

- \* S9070SB cannot be arranged by T14SG.
  - \* With some S.BUS(2) servos, there are some functions which cannot be used. If a function cannot be used, the display screen will change.
- (Only the function which can be used by a servo is displayed.)

\* After reading completion, with connection of the above figure, if a stick is moved, the test of operation of the servo can be operated and carried out.

## Procedure for changing S.BUS servo setting

1. Select [SBUS SERVO] of the System Menu.
2. Wire the servo as shown in the figure above.
3. Press [RECALL] on page 3 ([S1 is pushed twice). The ID and current setting of that servo are displayed. ([RECALL] is chosen ⇒ RTN is pushed ⇒ RTN is pushed for 1 second)
4. When multiple servos are connected change [INH] at the right side of the ID number on the screen to [ACT] and enter the ID of the servo you want to set.
5. Set each item. (Please see the next page.)
6. Press [WRITE] on page 3 ([WRITE] is chosen ⇒ RTN is pushed ⇒ RTN is pushed for 1 second). The settings are changed.

Push [INIT.], if you would like to initialize a setup of a servo. ([INIT.] is chosen ⇒ RTN is pushed ⇒ RTN is pushed for 1 second)

---

## S.BUS Servo Description of function of each parameter

\*There are a function which can be used according to the kind of servo, and an impossible function.

### • ID

Displays the ID of the servo whose parameters are to be read. It cannot be changed.

### • Channel

Channel of the S.BUS system assigned to the servo. Always assign a channel before use.

### • Reverse

The direction in which the servo rotates can be changed.

### • Servo type

When "Retractable" is selected and the servo has been continuously stopped for 30 seconds, the dead band expands and unnecessary hold current due to external force is eliminated. When a new control signal enters, normal operation is resumed. When using the servo as a landing gear servo, select "Retractable". Also adjust the servo travel to match the landing gear movement range.

### • Soft Start

Restricts operation in the specified direction the instant the power is turned on. By using this setting, the first initial movement when the power is turned on slowly moves the servo to the specified position.

### • Stop Mode

The state of the servo when the servo input signal is lost can be specified. The "Hold" mode setting holds the servo in its last commanded position even if using AM or FM system.

### • Smoother

This function changes smoothness of the servo operation relative to stick movement changes. Smooth setting is used for normal flight. Select the "OFF" mode when quick operation is necessary such as 3D.

### • Neutral Offset

The neutral position can be changed. When the neutral offset is large value, the servo's range of travel is restricted on one side.

### • Speed Control

Speeds can be matched by specifying the operating speed. The speed of multiple servos can be matched without being affected by motor fluctuations. This is effective for load torques below the maximum torque.

However, note that the maximum speed will not be exceed what the servo is capable of even if the servos operating voltage is increased.

### • Dead band

The dead band angle at stopping can be specified.

#### [Relationship between dead band set value and servo operation]

Small → Dead band angle is small and the servo is immediately operated by a small signal change.

Large → Dead band angle is large and the servo does not operate at small signal changes.

**(Note)** If the dead band angle is too small, the servo will operate continuously and the current consumption will increase and the life of the servo will be shortened.

### • Travel Adjust

The left and right travels centered about the neutral position can be set independently.

### • Boost

The minimum current applied to the internal motor when starting the servo can be set. Since a small travel does not start the motor, it essentially feels like the dead band was expanded. The motor can be immediately started by adjusting the minimum current which can start the motor.

#### [Relationship between boost set value and servo operation]

Small → Motor reacts to a minute current and operation becomes smooth.

Large → Initial response improves and output torque increases. However, if the torque is too large, operation will become rough.

---

### • Boost ON/OFF

OFF : It is the boost ON at the time of low-speed operation.(In the case of usual)

ON : It is always the boost ON.(When quick operation is hope)

### • Damper

The characteristic when the servo is stopped can be set.

When smaller than the standard value, the characteristic becomes an overshoot characteristic. If the value is larger than the standard value, the brake is applied before the stop position.

Especially, when a large load is applied, overshoot, etc. are suppressed by inertia and hunting may occur, depending on the conditions. If hunting (phenomena which cause the servo to oscillate) occurs even though the Dead Band, Stretcher, Boost and other parameters are suitable, adjust this parameter to a value larger than the initial value.

#### [Relationship between damper set value and servo operation]

Small → When you want to overshoot. Set so that hunting does not occur.

Large → When you want to operate so that braking is not applied. However, it will feel like the servo response has worsened.

**(Note)** If used in the hunting state, not only will the current consumption increase, but the life of the servo will also be shortened.

### • Stretcher

The servo hold characteristic can be set. The torque which attempts to return the servo to the target position when the current servo position has deviated from the target position can be adjusted.

This is used when stopping hunting, etc., but the holding characteristic changes as shown below.

#### [Relationship between stretcher and servo operation]

Small → Servo holding force becomes weaker.

Large → Servo holding force becomes stronger.

**(Note)** When this parameter is large, the current consumption increases.

### • Buzzer

When the power supply of a servo is previously turned on at the time of a power supply injection without taking transmit of a transmitter, the buzzer sound of about 2.5 Hz continues sounding from a servo.

(Even when the transmit of a transmitter is taken out previously, a buzzer becomes until the signal of a servo is outputted normally, but it is not unusual.)

The transmitter has been turned OFF ahead of a servo power supply → The buzzer sound of about 1.25 Hz continues sounding as servo power supply end failure alarm.

(Do not insert or remove the servo connector while the receiver power is ON. A buzzer may sound by incorrect recognition.)

\* Buzzer sound is generated by vibrating the motor of a servo.

Since current is consumed and a servo generates heat, please do not operate the number more than needed or do not continue sounding a buzzer for a long time.

# FUNCTIONS OF LINKAGE MENU

The Linkage Menu is made up of functions which perform model addition, model type selection, system type, end point setting, and other model basic settings.

The functions which can be selected depend on the model type. A typical menu screen is shown below.

- Access the Linkage menu shown below by tapping the LNK button two times.

- Select the function name and return to the Linkage menu by touching the RTN button. Or a HOME/EXIT button is pushed.

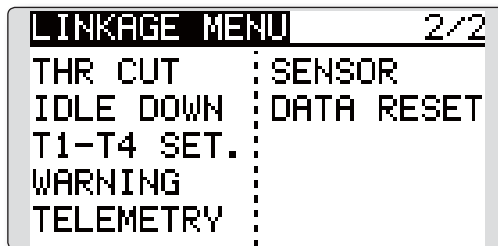
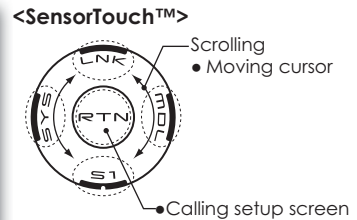
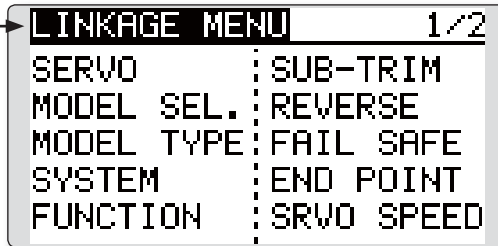

\*The display screen is an example. The screen depends on the model type.

- Select the function you want to set and call the setup screen by touching the RTN button.

## Linkage Menu functions table

- [SERVO]: Displays the servo test and operation position
- [MODEL SEL]: Model addition, call, deletion, copy, model name setting
- [MODEL TYPE]: Model type, wing type, swash type, etc. selection
- [SYSTEM]: System mode selection, link of a transmitter and receiver, area mode selection
- [FUNCTION]: Channel assignment of each function can be changed
- [SUB-TRIM]: Adjusts the neutral position of each servo
- [REVERSE]: Reverses the servo travel direction
- [FAIL SAFE]: Fail safe function and battery fail safe function setting
- [END POINT]: Servo travel adjustment and limit setting
- [SERVO SPEED]: Speed setup of a servo
- [THR CUT]: Stops the engine safely and easily (airplane and helicopter only)
- [IDLE DOWN]: Lowers the idle speed of the engine (airplane only)
- [SWASH RING]: Limits the swash plate travel to within a fixed range. (helicopter only)
- [SWASH]: Swash AFR and linkage correction function (helicopter only)
- [T1-T4 SET.]: Control step amount and mode selection of the digital trim
- [WARNING]: Mixing warning normal reset
- [TELEMETRY]: Displays various data sent from the receiver.
- [SENSOR]: Various telemetry sensors setting
- [DATA RESET]: Model memory set data reset

## SERVO MONITOR Servo Test & Graph Display / Displays servo positions.

This is used for testing servo movement. “Moving Test” (repetition mode) and “Neutral Test” (fixed position mode) are available.

The “Neutral Test” is good for finding the neutral position of a servo horn.

In order to prevent any potential difficulties, the servo test function will be inoperable, or inaccessible, under certain conditions. Specifically, the Servo Test function is not operational if the Throttle Cut is ON in either airplane or helicopter modes; or if the Throttle Hold is ON in Helicopter mode.

- A [U.MENU/MON.] button is pushed once from a home screen.
- Select [SERVO] in the Linkage menu and access the setup screen shown below by touching the RTN button.

- Select the function name and return to the Linkage menu by touching the RTN button. Or the HOME/EXIT button is pushed.

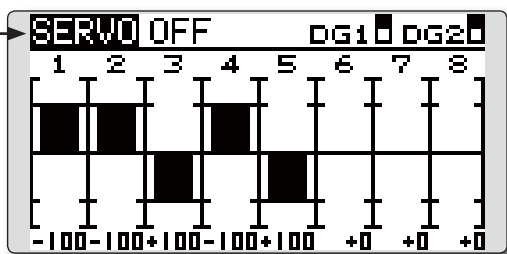

<SensorTouch™>

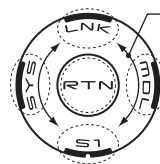

Scrolling

- Moving cursor
- Selecting mode

### Servo test operation

1. Move the cursor to the [OFF] item and touch the RTN button to switch to the data input mode.

Select the test mode by scrolling the touch sensor and touch the RTN button. The display blinks. Touch the RTN button to change the mode. (To terminate mode change, touch the S1 button.)

[MOVING]: Mode which repeats operation of each servo

[NEUTRAL]: Mode which locks each servo in the neutral position

2. Move the cursor to the [MOVING] or [NEUTRAL] item and touch the RTN button to switch to the data input mode.

Select the [OFF] by scrolling the touch sensor and touch the RTN button. Testing is stopped.

# MODEL SELECT

The Model Selection function performs model addition, selection, deletion, copy, and model name setting.

This function is used to load the settings of the desired model into the T14SG's memory.

The settings may be selected from either the transmitter's internal memory or an SD card. Remember that up to 30 model memories are available in the transmitter.

The name of the model stored in the transmitter and the SD card may be changed. This can be very useful to tell different models settings apart. Each model name can be as long as 10 characters, and the model name always appears in the display screen.

The Copy function is used to copy parameters, settings, etc. from one model data into a second memory. It may be used for getting a head-start on setting up models with almost the same settings (only differences need to be modified, instead of entering the complete model from scratch). Also, this function may be used to make a backup copy of a model setup before any changes are made.

\*T14SG can use the model data of T8FGS for SD card, copying it. However, the model data of T14SG cannot be used by T8SG (S).

- Select [MODEL SELECT] in the Linkage menu and access the setup screen shown below by touching the RTN button.

• Select the function name and return to the Linkage menu by touching the RTN button. Or the HOME/EXIT button is pushed.

Current model

<SensorTouch™>

Scrolling  
 • Moving cursor  
 • Selecting mode

\*The display screen is an example. The screen depends on the model type.

## Model selection

\*Model data saved on the transmitter memory other than the model currently used can be selected.

1. Move the cursor to the save destination display ("TX" or "CARD") and touch the RTN button to switch to the data input mode. Select the save destination by scrolling the touch sensor and touch the RTN button.  
 [TX]: Transmitter memory  
 [CARD]: SD card
2. After moving the cursor to the desired model in the model list, touch the RTN button.
3. Move to [SELECT].
4. Touch the RTN button. A confirmation message is displayed. Touch the RTN button for one second and selection is complete.

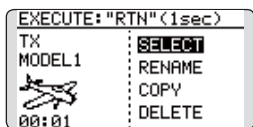

\*Transmission stops and then starts in the new model.

## Model addition

\*A new model can be added to the transmitter memory. It can not be added to the SD card.

1. Move the cursor to [NEW].
2. Touch the RTN button. A confirmation message appears. Touch the RTN button for one second.



\*The model type setup screen and frequency setup screen are automatically displayed. Confirm or change the model type and SYSTEM mode.

\*Transmission stops and then starts in the new model.

\*The added model appears in the model list of the model select setup screen.

**\*Link is required when a new model is made from a model selection.**

## Model deletion

\*The model stored in the transmitter memory or an SD card can be deleted.

\*The current model can not be deleted.

1. Move the cursor to the save destination display ("TX" or "CARD") and touch the RTN button to switch to the data input mode.

Select the save destination by scrolling the touch sensor and touch the RTN button.

[TX]: Transmitter memory

[CARD]: SD card

2. Move the cursor to the model you want to delete in the model list and then touch the RTN button.
3. Move the cursor to [DELETE].
4. Touch the RTN button. When a confirmation message is displayed and the RTN button is touched for one second, the model is deleted.

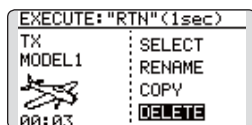

## Model name change

\*The model name of the model stored in the transmitter memory or a SD card can be changed.

1. If changing the location:

Move the cursor to the save destination display ("TX" or "CARD") and touch the RTN button to switch to the data input mode.

Select the save destination by scrolling the touch sensor and touch the RTN button.

[TX]: Transmitter memory

[CARD]: SD card

2. Move the cursor to the model you want to change in the model list and then touch the RTN button.
3. Move to [RENAME].
4. Touch the RTN button.

\*The model name setup screen is displayed.

User name (candidate)



5. Change the model name as described below:

[Moving cursor in the user name (candidate)]

Select [←] or [→], and touch the RTN button.

[Deleting a character]

When [DELETE] is selected and the RTN button is touched, the character immediately after the cursor is deleted.

[Adding a character]

When a character is selected from the character list and the RTN button is touched, that character is added at the position immediately after the cursor.

\*A name of up to 10 characters long can be entered as the model name. (A space is also counted as one character.)

6. After the desired information has been input, select [ENTER] and touch the RTN button. (To terminate input and return to the original state, select [CANCEL] and touch the RTN button.)

## Model copy

\*A copy can be made of the model stored in the transmitter memory or an SD card.

1. If changing the location:

Move the cursor to the save destination display ("TX" or "CARD") and touch the RTN button to switch to the data input mode.

Select the save destination by scrolling the touch sensor and touch the RTN button.

[TX]: Transmitter memory

[CARD]: SD card

2. Select the model you want to copy in the model list and then touch the RTN button.
3. Move to [COPY].
4. Touch the RTN button.

\*The copy screen appears.

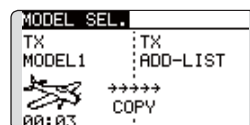

5. If replacing the model stored in the transmitter memory:

Move to [ADD-LIST] and touch the RTN button to switch to the data input mode.

Select the destination model by scrolling the touch sensor and touch the RTN button.

[ADD-LIST]: adding the model to the list

[(model name)]: replacing the model

\*The model stored in the SD card can be replaced.

If changing the location:

Move the cursor to the copy destination display ("TX" or "CARD") and touch the RTN button to switch to the data input mode.

Select the save destination by scrolling the touch sensor and touch the RTN button.

6. Move to [COPY].
7. Touch the RTN button. When a confirmation message is displayed and the RTN button is touched for one second, the model data is copied.

# MODEL TYPE

This function selects the model type from among airplane, helicopter, and glider.

Six swash types are available for helicopters. Six types of main wings and three types of tail wings are available for airplanes and gliders. Functions and mixing functions necessary for each model type are set in advance at the factory.

**Note: The Model Type function automatically selects the appropriate output channels, control functions, and mixing functions for the chosen model type.**

**When the Model Type selection command is accessed, all of the data in the active memory is cleared (except the following swash type.) Be sure that you don't mind**

**losing this data, or back it up to another memory using the copying functions.**

**When changing the helicopter swash type within the following groups, you can leave the settings other than the SWASH function. However, this is initialized when you change the swash type to the other swash type group.**

|   |
|---|
| <b>Swash type group A:</b><br>H-1, H-3, HR3, and HE3<br><b>Swash type group B:</b><br>H-4, H-4X |
|---|

- Select [MODEL TYPE] in the Linkage menu and access the setup screen shown below by touching the RTN button.

- Select the function name and return to the Linkage menu by touching the RTN button. Or the HOME/EXIT button is pushed.

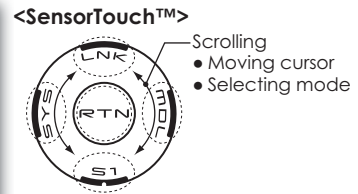
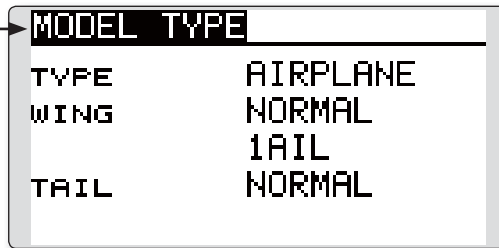

(The display screen is an example. The screen depends on the model type.)

## Model type selection

1. Move the cursor to the item you want to change and touch the RTN button to switch to the data input mode.

Select the desired type by scrolling the touch sensor and touch the RTN button. A confirmation message appears. Touch the RTN button for one second.

Move to [YES] and Touch the RTN button for one second.

(To terminate input and return to the original state, touch the S1 button or select [NO] and touch the RTN button.)

- "TYPE": Model type
- "WING " (airplane/glider): Wing type
- "TAIL" (airplane/glider): Tail type
- "SWASH" (helicopter): Swash type

\*The wing types which can be selected depend on the mode; FASST, Multi-ch, or 7ch, etc.

2. If resetting the data when changing the helicopter swash type:

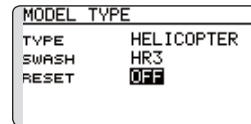

(Helicopter)

Move the cursor to [OFF] and touch the RTN button to switch to the data input mode.

Select [ON] by scrolling the touch sensor and touch the RTN button. A confirmation message appears. Touch the RTN button.

Activate the swash type setting. The swash setting parameters are reset.



## Model type selection (Airplane, Glider)

### •Wing type (Normal)

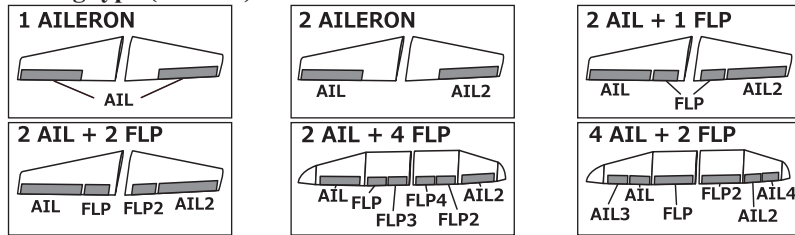

### •Wing type (Tailless wing)

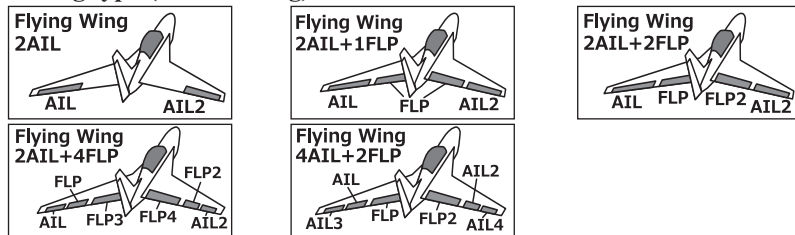

### •Rudder type



### •Tail type

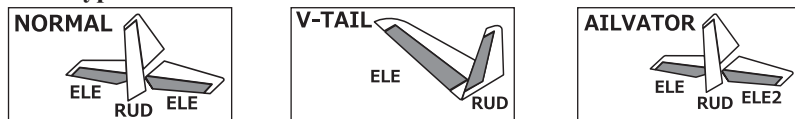

## Model type selection (Helicopter)

### •Swash type

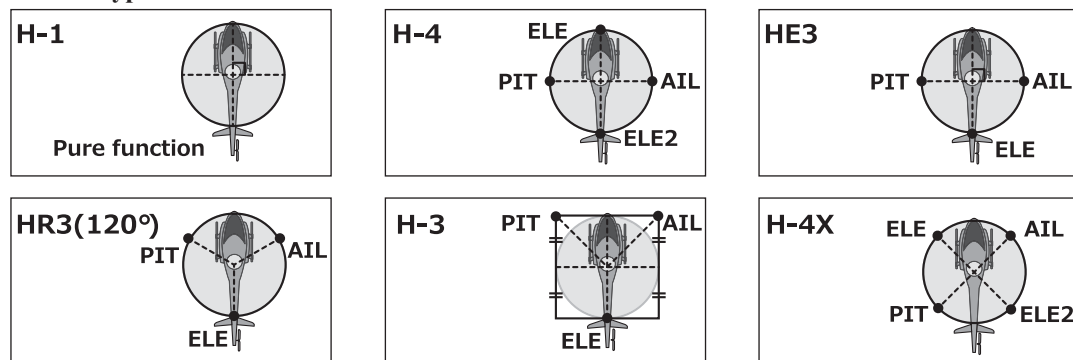

## System Type selection

The T14SG is for 2.4GHz only. The system can be changed from among 5 choices: FASSTest 14CH, FASSTest 12CH, FASST MULTI, FASST 7CH, S-FHSS. It is FASSTest14CH and FASSTest12CH which can be chosen by R7008SB set. The method of selection is to the next page.

- \*If you change the System Type, other model data is not reset.
- \*If a system type is changed in Helicopter mode, the transmitter will offer two selections:
- [Yes] : Selection sets the channel order suitable for System Type. (We recommend here. )
- [No] : The present channel order is maintained.
- \*After any change, remember to test the model and should fully check servo direction and a motion.
- \*Analog servos cannot be used with the R7008SB in the

FASSTest 12CH mode.

## Dual receiver function (only FASSTest 14CH mode)

Dual receivers can be linked with the T14SG. Two receivers are recognized individually by ID numbers. For example, in R7008SB, CH output setting function is used, by setting the first as "1-8CH", and setting the second as "9-14CH", two sets of receivers can be used as a set in the model, allowing you 14 channels. If a Dual receiver function is used, the following function can set up individually.

- Battery fail-safe voltage setup
- Telemetry function ON/OFF
- Sensor setup

- Select [SYSTEM] in the Linkage menu and access the setup screen shown below by touching the RTN button.

- Select the function name and return to the Linkage menu by touching the RTN button. Or the HOME/EXIT button is pushed.

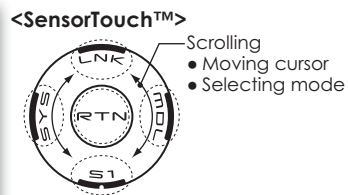
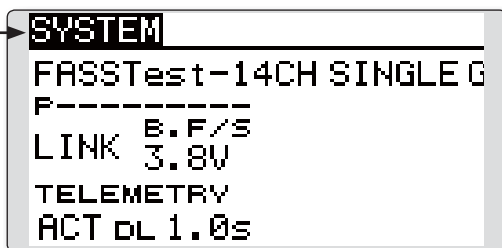

## Area mode selection (Frequency range)

The T14SG transmitter has been designed to function in many countries. If you will be utilizing this transmitter in a country other than France, please make sure that [AREA] is set to "G". If, however, this transmitter will be utilized in France, it must be set to "F" in order to comply with French regulations. FASST mode selection

## Receiver linking

The receiver will only be controlled (without being affected by other transmitters) by the transmitter it is linked to. When using a receiver other than one purchased as a set, linking is necessary.

Moreover, a re-link is required when a new model is added by model selection, and the time of system type change.

**Linking method**

### Cases when linking is necessary:

- When using a receiver other than the initial setting.
- When the communication system was changed. (FASSTest14CH ↔ FASSTest12CH etc.)
- When a new model was created by model selection.

## Battery fail-safe voltage setup (only FASSTest mode)

The voltage which battery fail-safe activates, can be set when you link. (3.5-8.4V) The receiver memorizes the setting as it was at link.

Suggested setting voltages are as follows.

- 4 cells NiCd or NiMH (Normal: 4.8v) = 3.8 v
- 2 cells LiFe (Normal: 6.6 v) = 6.0 ~ 6.2 v
- 2 cells LiPo (Normal: 7.4 v) = 7.2 ~ 7.4 v

It is a rough reference value.

Since it changes with servos carried in the condition and the model of a battery, please set to your own model in a battery consumption current.

## Telemetry function (FASSTest mode only)

To use the telemetry function, set “Telemetry” to “ACT”.

## DL Interval (FASSTest mode only)

When a telemetry function is enabled, the receiving interval (down-link interval) of sensor data can be changed.

If a DL interval is increased, the response of the sensor data display becomes slower, but stick response will improve.

## System Type selection procedure

1. Move the cursor to the [FASSTest-14CH] item and touch the RTN button to switch to the data input mode.

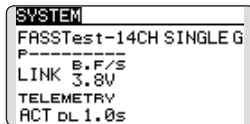

2. Select the system type by scrolling the touch sensor.  
[FASSTest-14CH][FASSTest-12CH][FASST-MULT][FASST-7CH][S-FHSS]  
\*An example of selections for each system is on the following page.
3. Touch the RTN button to end adjustment and return to the cursor mode.

## Dual receiver function (only FASSTest 14CH mode) procedure

1. Move the cursor to the [SINGLE] item and touch the RTN button to switch to the data input mode.

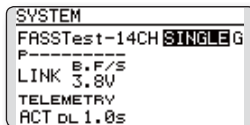

2. Select the [SINGLE] or [DUAL] by scrolling the touch sensor.

ID of a Primary receiver displays.

ID of a Secondary receiver displays.

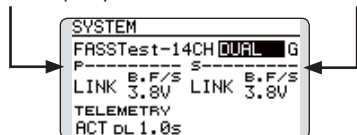

In DUAL, a primary receiver is link previously. Next, a secondary receiver is link.

3. Touch the RTN button to end adjustment and return to the cursor mode.

## Area mode selection (Frequency range) procedure

### procedure

1. Move the cursor to the [G] item and touch the RTN button to switch to the data input mode.

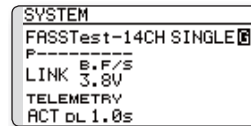

2. Select the [G] or [F] by scrolling the touch sensor.  
\*“F” is chosen only when using the transmitter is used in France. Leave this in “G” otherwise.
3. Touch the RTN button to end adjustment and return to the cursor mode.

## Telemetry ACT/INH procedure

1. Move the cursor to the TELEMETRY [ACT] item and touch the RTN button to switch to the data input mode.

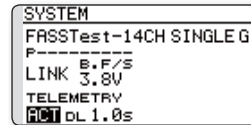

2. Select the [ACT] or [INH] by scrolling the touch sensor.
3. Touch the RTN button to end adjustment and return to the cursor mode.

## DL Interval set procedure

1. Move the cursor to the TELEMETRY DL[1.0s] item and touch the RTN button to switch to the data input mode.

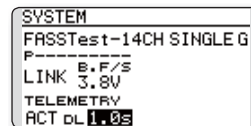

2. Select the DL time by scrolling the touch sensor. If a DL interval is increased, the response of the sensor data display becomes slower, but stick response will improve.

Initial value: 1.0s

Adjustment range : 0.1s~2.0s

3. Touch the RTN button to end adjustment and return to the cursor mode.

## The example for choosing System Type

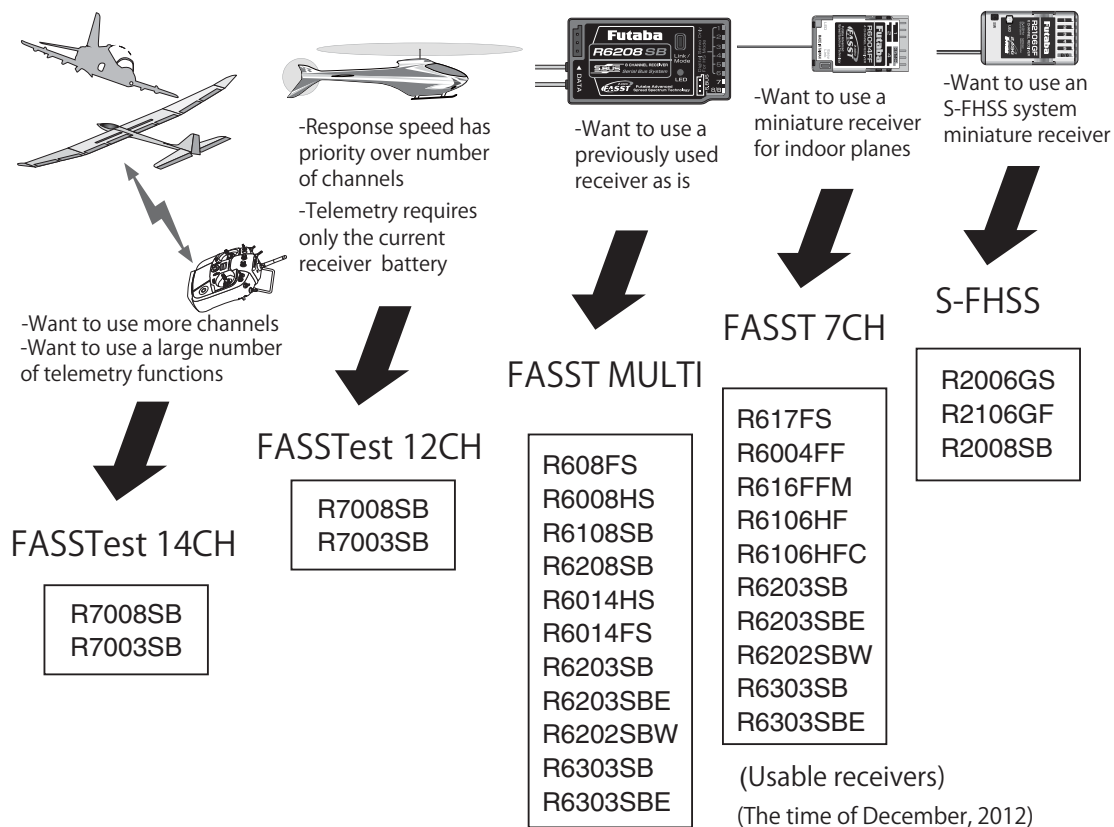

### System Type

- **FASSTest 14CH** --- FASSTest system receiver mode. Applicable with the telemetry sensor unit. Up to 18 channels (linear 12+ON/OFF2) can be used.
- **FASSTest 12CH** --- FASSTest system receiver mode. Applicable with receiver voltage display. Up to 12 channels (linear 10+ON/OFF2) can be used. Telemetry Sensor cannot be used, but the response speed is a faster than that of the 14CH mode.
  - Analog servos cannot be used with the R7008SB in the FASSTest 12CH mode.
- **FASST MULTI** --- FASST-MULTI system receiver mode. Up to 14 channels (linear 12+ON/OFF2) can be used.
- **FASST 7CH** --- FASST-7CH system receiver mode. Up to 7 channels can be used.
- **S-FHSS** --- S-FHSS system receiver mode. Up to 8 channels can be used.

When you select model and wing (swash) types, you will find that the optimized combinations of servo output channels and functions have been already preset. If you would like, you can freely change combinations of servo output channels, functions (aileron, elevator, etc), and control (sticks, switches, and trim levers).

\*You can also assign the same function to multiple servo output channels such as assigning elevator function to CH2 and CH3.

## Channel Replacement

When the channel is replaced in the Function menu, replaced channel uses the setting data (ATV, SUB-TRIM, REVERSE, F/S, and B-F/S, etc.).

## Servo Output Channels

For FASSTest 14CH mode, you can set 12 linear channels and two digital channels. For FASSTest 12CH mode, you can set 10 linear channels and two digital channels. For FASST MULT mode, you can set 12 linear channels and two digital channels.

For FASST 7CH mode, you can set only 7 linear channels. For S-FHSS mode, you can set only 8 linear channels.

\*DG1/2 (digital channels)

These channels can function as switched channels. You can freely change combinations between servo output channels and input controls (sticks, switches, and trim levers).

## Motor Function

If you have either a Glider or Airplane Model Type selected, and choose to activate the Motor function, a reverse setting screen is displayed.

\*If YES is selected, the output is reversed. If NO is selected, the output is normal.

## ⚠ Warning

As a safety precaution to prevent the motor from starting unexpectedly, please switch off the motor accordingly. We also suggest removing the propeller from the motor as an additional precaution.

- Select [FUNCTION] in the Linkage menu and access the setup screen shown below by touching the RTN button.

- Select the function name and return to the Linkage menu by touching the RTN button. Or the HOME/EXIT button is pushed.



|          |        |          |
|----------|--------|----------|
| FUNCTION | NORMAL | 1/4      |
|          | CTRL   | TRIM     |
| 1 AIL    | J1     | T1 SEPAR |
| 2 ELE    | J3     | T3 SEPAR |
| 3 THR    | J2     | T2 SEPAR |
| 4 RUD    | J4     | T4 SEPAR |

- Trim operation mode "COMB": Combination mode "SEPAR": Separate mode It sets up by T1-T4 SET of LINKAGE MENU.

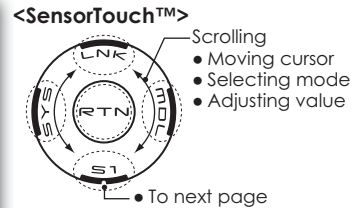

(The display screen is an example. The screen depends on the model type.)

## Function change

1. Move the cursor to the function item of the channel you want to change and touch the RTN button.

\*The function selection screen is displayed.

2. Move the cursor to the function name you want to set and touch the RTN button.

\*The function name blinks.

3. Touch the RTN button to execute the change. (When you want to cancel this operation, touch the S1 button.)

\*Multiple channels can be assigned to one function.

## Operation control change

1. Move the cursor to the "CTRL" item of the channel you want to change and touch the RTN button.

\*The control selection screen is displayed.

|                   |
|-------------------|
| H/W SELECT        |
| J1 SA SE LD T1    |
| J2 SB SF RD T2    |
| J3 SC SG LS T3    |
| J4 SD SH RS T4 -- |

2. Move the cursor to the control you want to change, and touch the RTN button.

\*The same control can be assigned to multiple channels.

## Camber/Motor/Butterfly control setting (glider)

\*Camber/Motor/Butterfly function control can be changed for each condition.

| FUNCTION | NORMAL    | 3/4 |
|----------|-----------|-----|
|          | CTRL TRIM |     |
| 9 CAMB   | LS G      | --  |
| 10 BFLY  | J2 G      | --  |
| 11 MOT   | SG G      | --  |
| 12 AUX1  | --        | --  |

Camber, Motor or Butterfly control group/single setting is performed at the function setup screen.

"G": Group (common to all conditions)

"S": Single (set for each condition)

## Trim setting

Move the cursor to the "TRIM" item of the channel you want to change and touch the RTN button.

\*The trim setup screen is displayed.

| H/W SELECT     | RATE   |
|----------------|--------|
| J1 SA SE LD T1 | +30%   |
| J2 SB SF RD T2 | MODE   |
| J3 SC SG LS T3 | NORMAL |
| J4 SD SH RS T4 | --     |

The following items can be set at the trim setup screen:

## Trim selection

Move the cursor to the trim, lever, etc. you want to set and touch the RTN button.

\*The setting can be changed.

## Trim rate setting

Move the cursor to the [RATE] item and touch the RTN button to switch to the data input mode.

Set the trim rate by scrolling the touch sensor.

Initial value: +30%

Adjustment range : -150~+150%

(When the RTN button is touched for one second, the trim rate is reset to the initial value.)

Touch the RTN button to end adjustment and return to the cursor mode.

## Trim mode selection

Move the cursor to the [MODE] item and touch the RTN button to switch to the data input mode.

Select the trim mode by scrolling the touch sensor. A confirmation message appears.

Touch the RTN button to change the mode. (To terminate input and return to the original state, touch the S1 button.)

[NORM]: Normal mode. Normal trim (parallel shift trim) operation.

[ATL]: ATL operation mode. Maximum change near idle or low-stick position, normally used with throttle trim. It is also possible to reverse the travel.

\*[NORMAL]/[REVERSE] selection is possible in "ATL" mode.

## Throttle trim (helicopter only)

\*The throttle trim in conditions other than "Normal" condition can be inhibited.

When other than normal condition is selected, move the cursor to throttle trim on the function setup screen and touch the RTN button for 1 second.

| FUNCTION | IDLEUP1   | 1/4        |
|----------|-----------|------------|
|          | CTRL TRIM |            |
| 1 AIL    | J1        | T1 SEPAR   |
| 2 ELE    | J3        | T3 SEPAR   |
| 3 THR    | J2        | X T2 SEPAR |
| 4 RUD    | J4        | T4 SEPAR   |

\*When "X" is displayed, THR trim is inhibited in conditions other than normal condition.

## Channel replacement

Move the cursor to the channel # you want to replace and touch the RTN button to switch to the data input mode.

Select the destination channel # by scrolling the touch sensor. A confirmation message appears. Touch the RTN button to replace the channel. (To terminate input and return to the original state, touch the S1 button.)

The Sub-Trim function is used to set the servo neutral position, and may be used to make fine adjustments to the control surface after linkages and pushrods are hooked up. When you begin to set up a model, be sure that the digital trims are set to their center position.

- Select [SUB-TRIM] in the Linkage menu and access the setup screen shown below by touching the RTN button.

• Select the function name and return to the Linkage menu by touching the RTN button. Or the HOME/EXIT button is pushed.



| SUB-TRIM |    |       |    | 1/2 |
|----------|----|-------|----|-----|
| 1AIL     | +0 | 5GEAR | +0 |     |
| 2ELE     | +0 | 6AIL2 | +0 |     |
| 3THR     | +0 | 7VPP  | +0 |     |
| 4RUD     | +0 | 8AUX5 | +0 |     |

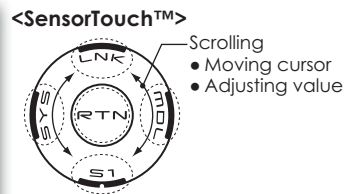

(The display screen is an example. The screen depends on the model type.)

## Sub-trim adjustment

1. Move the cursor to the channel you want to adjust and touch the RTN button to switch to the data input mode.
2. Adjust the rate by scrolling the touch sensor.  
Initial value: 0  
Adjustment range: -240~+240 (steps)  
(When the RTN button is touched for one second, sub-trim is reset to the initial value.)  
\*Before sub-trim adjustment, it is very important to adjust the linkages at the control surface so that you do not use sub-trim, except for very minute adjustments.
3. Touch the RTN button to end adjustment and return to the cursor mode.
4. Repeat this procedure for each channel.

# REVERSE

Use to reverse the throw direction.

Servo Reverse changes the direction of an individual servo's response to a control input.

For CCPM helicopters, be sure to read the section on Swash AFR before reversing any servos. With CCPM helicopters, always complete your servo reversing prior to any other programming. If you use pre-built Airplane/Sailplane functions that control multiple servos, it may be confusing

to tell whether the servo needs to be reversed or a setting in the function needs to be reversed. See the instructions for each specialized function for further details. Always check servo direction prior to every flight as an additional precaution to confirm proper model memory, hook ups, and radio function.

- Select [REVERSE] in the Linkage menu and access the setup screen shown below by touching the RTN button.

• Select the function name and return to the Linkage menu by touching the RTN button. Or the HOME/EXIT button is pushed.



**REVERSE** 1/2

|             |              |
|-------------|--------------|
| 1 AIL NORM  | 6 AIL2 NORM  |
| 2 ELE NORM  | 7 VPP NORM   |
| 3 THR NORM  | 8 AUX5 NORM  |
| 4 RUD NORM  | 9 CAMB NORM  |
| 5 GEAR NORM | 10 AUX1 NORM |

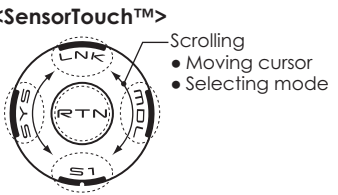

(The display screen is an example. The screen depends on the model type.)

## Servo reversing procedure

\*Upon setup completion of a new model, check whether or not each servo is connected to the correct channel.

\*Next, determine whether you need to reverse any channels by moving each stick and/or other control inputs.

1. Move the cursor to the channel you want to reverse and touch the RTN button to switch to the data input mode.
2. Select the direction by scrolling the touch sensor. A confirmation message appears.

[NORM]: Normal

[REV]: Reverse

3. Touch the RTN button to change the direction. (To terminate input and return to the original state, touch the S1 button.)

\*Repeat the operation above for each channel that must be reversed.



## FAIL SAFE

Sets the servos operating position when transmitter signals can no longer be received or when the receiver battery voltage drops.

The Failsafe function may be used to set up positions that the servos move to in the case of radio interference.

You may set either of two positions for each channel: Hold, where the servo maintains its last commanded position, or Failsafe, where each servo moves to a predetermined position. You may choose either mode for each channel. (**FASST 7CH mode: CH3 only**)

The T14SG system also provides you with an advanced battery monitoring function that warns you when the receiver battery has only a little power remaining. In this case, each servo is moved to the defined failsafe position. (**FASST 7CH mode: CH3 only**) The battery failsafe may be released by operating a predefined control on the transmitter (default is throttle), do not continue to fly, land as soon as possible. Remember, if the

predefined control suddenly moves to a position you did not command, land at once and check your receiver battery.

Defines servo position when signals are lost and when receiver battery voltage becomes low.

### ⚠ Warning

❗ For safety, always set the fail safe functions.

- Remember to set the throttle channel fail safe function so that the servo moves to the maximum slow side for airplanes and to the slow side from the hovering position for helicopters. Crashing of the model at full high when normal radio waves cannot be received due to interference, etc., is very dangerous.
- If the battery fail safe is reset by the throttle stick, it may be mistaken for an engine malfunction and will be reset at throttle slow and the model will continue to fly. If you have any doubts, immediately land.

- Select [FAIL SAFE] in the Linkage menu and access the setup screen shown below by touching the RTN button.

- Select the function name and return to the Linkage menu by touching the RTN button. Or the HOME/EXIT button is pushed.

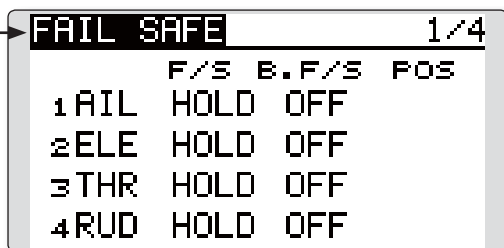

(The display screen is an example. The screen depends on the model type.)

<SensorTouch™>

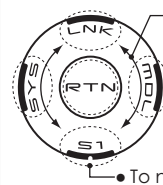

- Scrolling
- Moving cursor
- Selecting mode
- Adjusting value

• To next page

### Fail safe setting procedure

1. Move the cursor to the "F/S" item of the channel you want to set and touch the RTN button to switch to the data input mode.
2. Select the F/S mode by scrolling the touch sensor. A confirmation message appears.  
\*The display blinks.
3. Touch the RTN button. (Touch the S1 button to stop setting.)  
\*The channel switches to the F/S mode.
4. Move the cursor to the "POS" item.  
Hold the corresponding stick, knob, slider, etc. in the position you want the servo to move to when the fail safe function is activated and Touch the RTN button for one second.

\*The set position is displayed in percentage.

\*If you want to return that channel to the hold mode, move the cursor to the "F/S" item and touch the RTN button to switch to the data input mode. Select the F/S mode by scrolling the touch sensor. A confirmation message appears and then change the mode by touching the RTN button.

### Battery fail safe setting procedure

Battery fail safe can be set for each channel by the same method as the fail safe setting procedure. Select and set the "B.F/S" item.

[ON]: Battery fail safe function ON

[OFF]: Battery fail safe function OFF

### Battery fail safe release switch setting

This function temporarily releases the battery fail safe function, so the fuselage can recover after the battery fail safe function was activated by a drop in the receiver battery voltage. This setting selects the switch which releases the battery fail safe function.

1. Move the cursor to the [RELEASE B.F/S] item in the setup screen (last page).
2. Touch the RTN button.

\*The switch selection screen is called.

\*For a detailed description of the switch selection and ON/OFF direction setting method, see [Switch Setting Method] at the back of this manual.

# END POINT

Sets the travel and limit point of each servo.

The End Point function adjusts the left and right servo throws, generates differential throws, and will correct improper linkage settings.

The travel rate can be varied from 0% to 140% in each direction on channels 1 to 12(FASSTest 12CH mode). Also, the limit point where servo throw stops may be varied from 0% to 155%.

- Select [END POINT] in the Linkage menu and access the setup screen shown below by touching the RTN button.

(The display screen is an example. The screen depends on the model type.)

• Select the function name and return to the Linkage menu by touching the RTN button. Or the HOME/EXIT button is pushed.

|   | END POINT | 1/3             |
|---|-----------|-----------------|
| 1 | AIL       | 135 100 100 135 |
| 2 | ELE       | 135 100 100 135 |
| 3 | THR       | 135 100 100 135 |
| 4 | RUD       | 135 100 100 135 |

(limit point) (travel) (travel) (limit point)

<SensorTouch™>

- Scrolling
- Moving cursor
- Adjusting value
- To next page

## Servo travel adjustment

1. Move the cursor to the travel icon of the channel you want to adjust and touch the RTN button to switch to the data input mode.
2. Adjust the rate by scrolling the touch sensor.  
Initial value: 100%  
Adjustment range: 0%~140%  
\*When the RTN button is touched for one second, the rate is reset to the initial value.  
Touch the RTN button to end adjustment and return to the cursor mode.
3. Repeat this procedure for each rate.

## Limit point adjustment

1. Move the cursor to the limit point icon of the channel you want to adjust and touch the RTN button to switch to the data input mode.
2. Adjust the limit point by scrolling the touch sensor.  
Initial value: 135%  
Adjustment range: 0%~155%  
\*When the RTN button is touched for one second, the limit point is reset to the initial value.  
Touch the RTN button to end adjustment and return to the cursor mode.
3. Repeat this procedure for each limit point.

# SERVO SPEED

Sets the speed of each servo.

The speed of the servo from 1CH to 12CH of operation can be set up.

It can adjust to 0-27.

Speed becomes slow as a numerical value's 0 increases in the state of the fastest of the servo.

\* Speed cannot be made quicker than the maximal rate of the servo to be used.

\* It will overlap, if speed control of a S.BUS servo setup is used at the time of S.BUS servo use, and speed changes. Please use one either.

\* The speed of THR is not set up simultaneously with THR DELAY (model menu : only airplane).

- Select [SERVO SPEED] in the Linkage menu and access the setup screen shown below by touching the RTN button.

- Select the function name and return to the Linkage menu by touching the RTN button. Or the HOME/EXIT button is pushed.

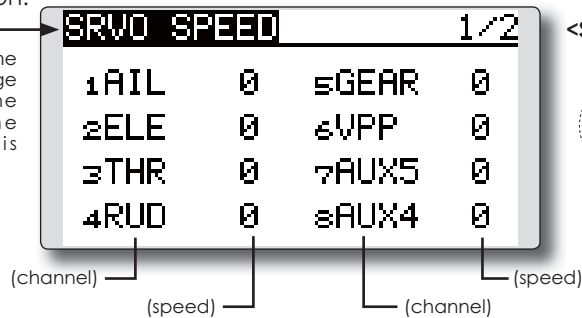

(The display screen is an example. The screen depends on the model type.)

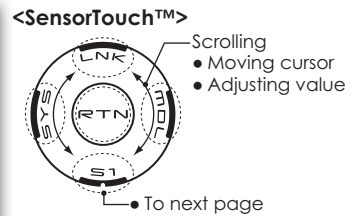

## Servo speed setting

1. Touch the Speed button of the channel you want to set.
2. Use the adjustment buttons to adjust the servo speed.

- Initial value: 0
- Adjustment range: 0~27 (steps)

\*When the RTN button is touched for one second, the rate is reset to the initial value.

3. Repeat this procedure for each channel.

# THR CUT

Stops the engine safely and easily. (airplane and helicopter only)

Throttle cut provides an easy way to stop the engine. Generally speaking, modelers will do so by flipping a switch with the throttle stick at idle. The action is not functional at high throttle to avoid accidental dead stick landings. The switch's location and direction must be chosen, as it defaults to NULL.

Individually adjust the Throttle Cut activation setting for each condition. (helicopter)

- Select [THR CUT] in the Linkage menu and access the setup screen shown below by touching the RTN button.
- Select the function name and return to the Linkage menu by touching the RTN button. Or the HOME/EXIT button is pushed.

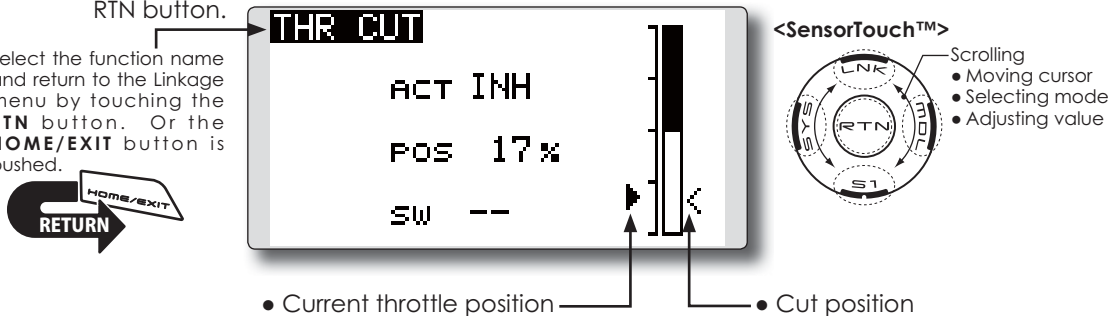

• Current throttle position      • Cut position

## Throttle cut setting procedure

### 1. Activate the function:

Move the cursor to the [ACT] item and touch the RTN button to switch to the data input mode.

Select the ACT mode by scrolling the touch sensor.

\*The display blinks.

Touch the RTN button to activate the function and return to the cursor mode.

### 2. Switch selection:

Move the cursor to the [SW] item and access the switch setup screen by touching the RTN button and select the switch and ON direction.

\*For a detailed description of the setting method, see [Switch Setting Method] at the back of this manual.

### 3. Throttle cut position setting:

Move the cursor to the [POS] item and touch the RTN button to switch to the data input mode.

Adjust the servo operation position at throttle cut operation by scrolling the touch sensor.

Initial value: 17%

Adjustment range: 0%~50%

\*When the RTN button is touched for one second, the servo operation position is reset to the initial value.)

Touch the RTN button to end the adjustment and return to the cursor mode.

\*Since conditions are not offered when an Airplane is selected, the Throttle Cut options will vary from the options noted below.

\*The Throttle Cut POS and SW settings are utilized for all conditions.

\*If the Throttle Cut switch is activated, or on, this status will continue even if the condition is changed to an inhibited setting.

\*If the condition is inhibited (INH) the Throttle Cut is off if the SW is in the off position and the throttle stick is low.

\*With the selected cut switch ON and the throttle stick at idle; adjust the rate until the engine consistently cuts off.

However, be sure that the throttle linkage is not pulled too tight or unreasonable force is not applied to the servo.

- Individually adjust the Throttle Cut activation setting for each condition. (helicopter)

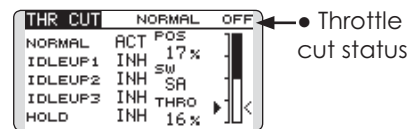

• Throttle cut status

## Designating a Throttle Cut setting position. (helicopter)

\*A throttle cut function acts in the low side of the throttle position.

\*"THRO" setting is common with all condition.

### ⚠ Warning

❗ Normal setting is slightly above idle.

1. To add the Throttle Cut position, use the cursor to select the THRO percentage desired, then press and hold the RTN button for one second.

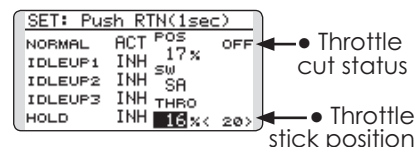

• Throttle cut status

• Throttle stick position

The Idle Down function lowers the engine to its idle position. Like Throttle Cut, this is usually accomplished by flipping a switch with the throttle stick at idle. The action is not functional at high throttle to avoid accidental dead sticks. The switch's location and direction must be chosen, as it defaults to NULL.

- Select [IDLE DOWN] in the Linkage menu and access the setup screen shown below by touching the RTN button.

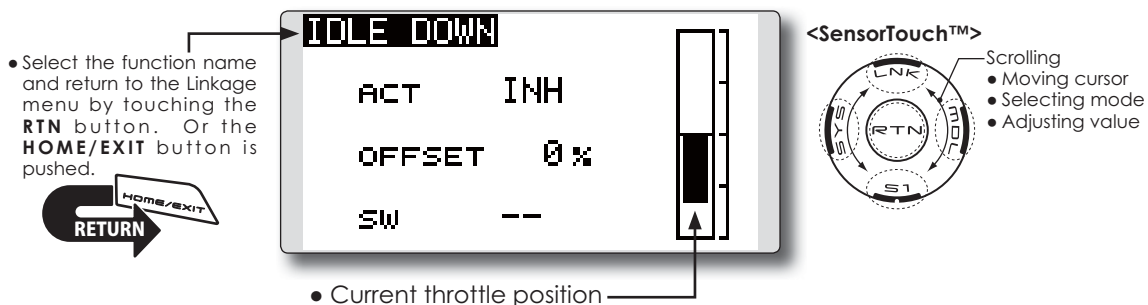

## Idle down setting procedure

### 1. Activate the function:

Move the cursor to the [ACT] item and touch the RTN button to switch to the data input mode.

Select the ACT mode by scrolling the touch sensor.

\*The display blinks.

Touch the RTN button to activate the function and return to the cursor mode.

### 2. Switch selection:

Move the cursor to the [SW] item and access the switch setup screen by touching the RTN button. Select the switch and ON direction.

\*For a detailed description of the setting method, see [Switch Setting Method] at the back of this manual.

### 3. Offset rate setting:

Move the cursor to the [OFFSET] item and touch the RTN button to switch to the data input mode.

Adjust the servo offset rate at idle down operation by scrolling the touch sensor.

Initial value: 0%

Adjustment range: -100%~0%~+100%

\*When a minus rate is input, an offset is applied at the high side.

\*Maximum offset amount is near maximum slow.

\*When the RTN button is touched for one second, the offset rate is reset to the initial value.

Touch the RTN button to end the adjustment and return to the cursor mode.

# SWASH RING

Limits the swash plate travel to within a fixed range. (Helicopter only)

This function limits the swash travel to a fixed range in order to prevent damaging the swash linkage by simultaneous operation of the ailerons and elevators. It is very useful in 3D aerobatics which use a large travel.

- Select [SWASH RING] in the Linkage menu and access the setup screen shown below by touching the RTN button.

- When the swash ring function is activated, a circle is displayed in the operating range display area and the rate input box is displayed. Stick operation is limited to the area of this circle.

• Select the function name and return to the Linkage menu by touching the RTN button. Or the HOME/EXIT button is pushed.

• The operating range display area: The vertical direction shows the elevator travel. The horizontal direction shows the aileron travel.

• The marker shows the stick position.

## Swash ring setting procedure

### 1. Activate the function:

Move the cursor to the [ACT] item and touch the RTN button to switch to the data input mode.

Select the ACT mode by scrolling the touch sensor.

\*The display blinks.

Touch the RTN button to activate the function and return to the cursor mode.

### 2. Rate setting:

Move the cursor to the [RATE] item touch the RTN button to switch to the data input mode.

Set the rate by scrolling the touch sensor.

Initial value: 100%.

Adjustment range: 50 to 200%.

\*Adjust the rate to maximum swash tilt.

\*When the RTN button is touched for one second, the rate is reset to the initial value.

Touch the RTN button to end adjustment and return to the cursor mode.

## Neutral Point

At your linkages, if the servo horn deviates from a perpendicular position at neutral, the linkage compensation functions in this menu may not compensate effectively. To correct this use the Neutral Point function. This will move the neutral point of the servos to the actual perpendicular position. However, this adjustment changes only the axis point of the compensation functions in this menu, and does not affect the neutral position of other functions.

## Swash AFR

Swash AFR function reduces, increases, or reverses the rate (travel) of the aileron, elevator and collective pitch functions, by adjusting or reversing the motion of all servos involved in that function, only when using that function.

## Mixing Rate

This mixing is used to compensate the swash-plate as necessary during specific control inputs.

The following compensation mixing is possible; PIT to AIL, PIT to ELE, AIL to PIT, ELE to AIL, and ELE to PIT (HR3 mode.) It adjusts the swash-plate to for proper operation of each control using the corresponding compensation mixing.

## Linkage Compensation

This compensation mixing is used to correct the swash-plate for pitch control at low pitch and high pitch.

## Speed Compensation

This function is used to cancel the reaction that is generated by the difference in the movements of each servo when the swash-plate moves.

## Subtrim

Subtrim for aileron, elevator and pitch can be set during swash setting.

## Pitch adjustment function

High, neutral and low pitch fixed outputs can be used while adjusting the pitch.

- Select [SWASH] in the Linkage menu and access the setup screen shown below by touching the RTN button.

- Select the function name and return to the Linkage menu by touching the RTN button. Or the HOME/EXIT button is pushed.



|              |     |      |  |
|--------------|-----|------|--|
| <b>SWASH</b> |     | 1/6  |  |
| NEUTRAL      | AFR |      |  |
| POS 50%      | AIL | +50% |  |
|              | ELE | +50% |  |
|              | PIT | +50% |  |

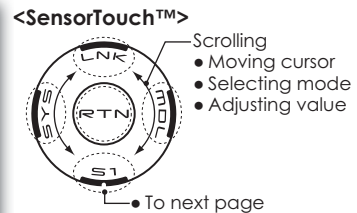

## Neutral point setting procedure

The neutral point becomes the correction standard point.

\*Adjusting the servo horn so that the neutral point is near the 50% position makes the mixing amount small.

### 1. Neutral point setting

Move the cursor to the [POS] item and hold the pitch operation so that the servo horn is at a right angle to the linkage rod and Touch the RTN button for one second. This value indicates the servo's neutral position.

After reading the neutral point, use the other correction functions to make further adjustments.

## Swash AFR setting procedure

The swash AFR function makes adjustments so that the servos travel the specified amount by [AIL], [ELE], and [PIT] operation.

1. Move the cursor to the function you want to adjust and touch the RTN button to switch to the data input mode.
2. Adjust the AFR rate by scrolling the touch sensor.

Initial value: +50%

Adjustment range: -100%~+100%

\*When the RTN button is touched for one second, the AFR rate is reset to the initial value.

Touch the RTN button to end adjustment and return to the cursor mode.

## Mixing rate setting procedure

The HR3 swash-plate type will be used as an example to describe mixing rate setting. The mixing used in other swash modes may be different, however, the setting procedure is the same.

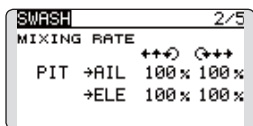

\*Set the throttle stick to the preset neutral point. Adjust the length of the linkage rod so that the swash plate is horizontal at this position.

\*The sub-trim function can be used to make small adjustments.

\*Adjust so that the pitch curve is a straight line and the helicopter achieves maximum pitch.

\*Move the cursor to the item you want to adjust and touch the RTN button to switch to the data input mode. Touch the RTN button to end adjustment and return to the cursor mode.

### 1. Adjusting the aileron operation [AIL to PIT]

Adjust the AIL to PIT rate so there is no binding in the elevator or pitch movement when the aileron stick is moved to the left and right.

\*Adjust by scrolling the touch sensor.

\*The left and right sides can be adjusted individually.

### 2. Adjusting the elevator operation [ELE to AIL]/ [ELE to PIT]

Adjust the ELE to AIL and ELE to PIT rates so there is no binding in the aileron or pitch movement when the elevator stick is moved up and down.

\*Adjust by scrolling the touch sensor.

\*The up and down sides can be adjusted individually.

### 3. Adjusting the pitch operation [PIT to AIL][PIT to ELE]

Adjust the PIT to AIL and PIT to ELE rates so that the swash plate moves to the level/horizontal position when the throttle stick was moved to maximum low and full high.

\*Adjust by scrolling the touch sensor.

\*The slow and high sides can be adjusted individually.

## Linkage compensation setting procedure

\*Prior to utilizing the linkage compensation settings, it is important to adjust the mixing rate settings.

\*Linkage compensation overrides interference from the aileron operation with the elevator or elevator operation with the aileron at collective pitch control for low pitch and high pitch.

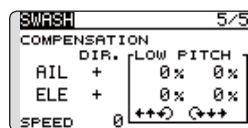

\*When making the following setting, Move the cursor to the item you want to set and touch the RTN button to switch to the data input mode. Touch the RTN button to end adjustment and return to the cursor mode.

### 1. Compensating aileron input [AIL]

Set the throttle stick to the lowest position. Move the aileron stick to the left and right and adjust the aileron compensation amount so that interference in the elevator or pitch direction is minimal.

\*Adjust by scrolling the touch sensor.

\*The left and right sides can be adjusted individually.

\*If the interference increases when the compensation amount was increased, make adjustments with the direction [DIR.] using the plus "+" or minus "-".

### 2. Compensating elevator input [ELE]

Adjust the elevator compensation amount so that the aileron or pitch direction interference when the elevator stick was moved up and down is minimal.

3. Repeat steps 1 and 2 above, perform aileron and elevator compensation similarly at full throttle.

## Speed compensation setting procedure

1. Move the cursor to the "SPEED" item and touch the RTN button to switch to the data input mode.

2. Set the throttle stick to the neutral point position. Quickly move the elevator stick and adjust the speed compensation amount [SPEED] for minimum interference in the pitch direction.

\*Adjust by scrolling the touch sensor.

Touch the RTN button to end adjustment and return to the cursor mode.



## Subtrim setting procedure

Subtrim can be set on the last page of the swash setting screen.

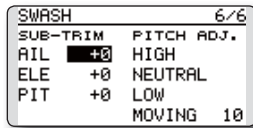

\*The sub-trim value set here is reflected at sub-trim of the linkage menu.

## Pitch adjustment procedure

The pitch adjustment function can be used on the last page of the swash setting screen.

1. Call the last page of the swash setting screen.
2. When the cursor is moved to a pitch adjustment button and the RTN button is touched, the corresponding pitch is output.

\* In the pitch adjustment mode an \* is displayed at the left side of the current output setting button.

\*If the cursor is moved to another button and the RTN button is touched during pitch adjustment, the pitch adjustment mode is deactivated.

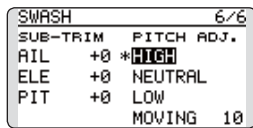
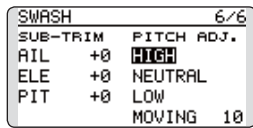

Function details are as follows:

| Button  | Function                        |
|---------|---------------------------------|
| High    | High pitch fixed output mode    |
| Neutral | Neutral pitch fixed output mode |
| Low     | Low pitch fixed output mode     |
| Moving  | Cyclic pitch output mode        |

\*The cyclic pitch speed can be set with the button at the right side of the "Moving" button.

Setting range: 1 to 100

\*When the set value is large, motion becomes fast and when the set value is small, motion becomes slow.

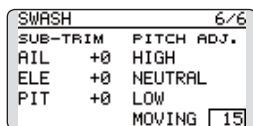

## T1-T4 SET.

### Digital trim settings

This function adjusts the digital trim's step amount and operation mode (T1~T4.)

When the flight conditions are set, the trim operation can be coupled with the conditions when combination mode is selected.

The T14SG unit of trim is displayed on the home screen.

Only the trim displayed on the home screen can be moved to the center position without changing the actual trim's memory position.

- Select [T1-T4 SET.] in the Linkage menu and access the setup screen shown below by touching the RTN button.
- Select the function name and return to the Linkage menu by touching the RTN button. Or the HOME/EXIT button is pushed.

| STEP | MODE    | UNIT         |
|------|---------|--------------|
| T1   | 4 SEPAR | --           |
| T2   | 4 SEPAR | T1-T4 MEMORY |
| T3   | 4 SEPAR | INH          |
| T4   | 4 SEPAR |              |

- Trim operation mode  
"COMB.": Combination mode  
"SEPAR": Separate mode

<SensorTouch™>

- Scrolling
- Moving cursor
- Selecting mode
- Adjusting value

• To next page

(The display screen is an example. The screen depends on the model type.)

### Control step amount setting

1. Move the cursor to the [STEP] item and touch the RTN button to switch to the data input mode.
2. Set the control step amount by scrolling the touch sensor.  
Initial value: 4  
Adjustment range: 0~200  
\*When the RTN button is touched for one second, the control step amount is reset to the initial value.  
\*When the value is increased, the change per step becomes larger.
3. Touch the RTN button to end adjustment and return to the cursor mode.

### Separate/combination mode selection (Heli and Glider only)

1. Move the cursor to the [MODE] item and touch the RTN button to switch to the data input mode.
2. Select the mode by scrolling the touch sensor. A confirmation message appears.  
\*The display blinks.  
[COMB.]: Combination mode. The trim's data is reflected in all flight conditions.  
[SEPAR]: Separate mode. Trim adjustments are made individually for each flight condition.
3. Touch the RTN button. (To terminate the input and return to the original state, touch the S1 button.)

### Display unit selection

1. Move the cursor to the [UNIT] item and touch the RTN button to switch to the data input mode.
2. Select the mode by scrolling the touch sensor. A confirmation message appears.  
\*The display blinks.  
[--]: A step number is displayed on the home screen. There is no unit display.  
[%]: "%" is displayed as a unit.
3. Touch the RTN button. (To terminate the input and return to the original state, touch the S1 button.)

### Trim Memory Operation procedure

1. Move the cursor to the [T1-T4 MEMORY] item and touch the RTN button to switch to the data input mode.
2. Select the ACT mode by scrolling the touch sensor. A confirmation message appears.  
[INH]: Inhibited \*The display blinks.  
[ACT]: Activated
3. Touch the RTN button. (To terminate the input and return to the original state, touch the S1 button.)
4. At the home screen, move the cursor to the trim you want to change and touch the RTN for one second. The trim display is moved to the center position.  
\*When the function is inhibited, the trim position returns to the actual trim position.

# WARNING

Low Battery alarm voltage set Warning normal reset

The T14SG includes an audible alarm that sounds when the transmitter's battery voltage drops below a pre-determined setting; adjustable for cell types and voltages.

Mixing warning at power ON can be reset to OFF.

## Warning display:

Airplane: Throttle cut/Idle down/Throttle position/Snap-roll/Motor position/Airbrake/Motor

Helicopter: Condition/Throttle cut/Throttle position/Throttle Hold

Glider: Condition/Motor position/Trim-mix/Motor

- Select [WARNING] in the Linkage menu and access the setup screen shown below by touching the RTN button.

- Select the function name and return to the Linkage menu by touching the RTN button. Or the HOME/EXIT button is pushed.

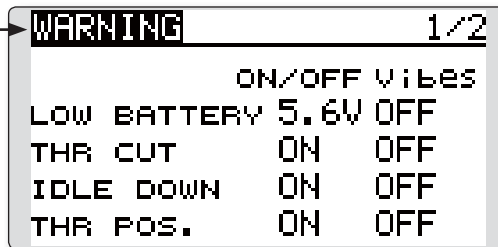

<SensorTouch™>

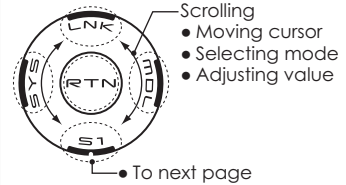

- Push S1 button to advance to next page.

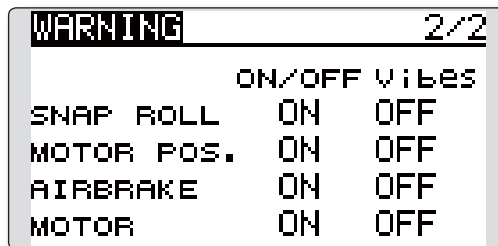

## Accessing and Activating the Low Battery Alarm

1. The Low Battery (LOW BATTERY) alarm voltage is accessed through the T14SG's System Menu. Within the System Menu, use the SensorTouch™ to highlight the SOUND option and then press the Return (RTN) button to confirm the selection.
2. Use the SensorTouch to scroll to the Low Battery (LOW BATTERY) alarm, and then press the Return (RTN) button to access the voltage settings. Using the SensorTouch, adjust the voltage as desired and/or determined by the transmitter battery pack being utilized. The voltage options range from 5.0V to 6.0V. Suggested voltage settings are as follows:

- 5-Cell NiCd or NiMH: 5.6V
- 2-Cell LiFe: 6.0V

\*About low battery voltage, all the models included in one transmitter are changed in common. It cannot set to different voltage for every model. Moreover, data reset is not carried out.

## Warning normally resetting method

1. Move the cursor to the item you want to reset to OFF and touch the RTN button to switch to the data input mode.
2. Select the OFF mode by scrolling the touch sensor.  
\*The display blinks.
3. Touch the RTN button. (To terminate the input and return to the original state, touch the S1 button.)

# TELEMETRY

## Displaying data from the receiver

This screen displays your choice of data from the receiver.

Also warnings can be activated regarding other data from your aircraft. For example, if the receiver voltage drops, the user can be warned by an alarm (and vibration).

\*It cannot be used in FASST mode and S-FHSS mode.

\*Only receiver voltage and EXT voltage can be used in FASSTest12CH mode.

\*The FASSTest14CH mode can use all the telemetry functions.

- **[TELEMETRY]** can be called if the **HOME/EXIT** button is pushed from a **home screen**.
- Select **[TELEMETRY]** in the Linkage menu and access the setup screen shown below by touching the RTN button.

- Select the function name and return to the Linkage menu by touching the RTN button. Or the HOME/EXIT button is pushed.



|   |            |
|---|------------|
| <b>TELEMETRY</b> <span style="float:right">Y 1/3</span> |            |
| Rx-BATT.  | 1 TEMP.    |
| 0.0V  | -----      |
| RECEIVER  | SBS-01T    |
| EXT-VOLT  | 2 RPM      |
| 0.0V  | 0rpm       |
| RECEIVER  | SBS-01RM/O |

- Receiver -> Transmitter. The reception strength is shown.

<SensorTouch™>

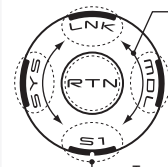

- Scrolling
- Moving cursor
- Selecting mode
- Adjusting value

• To next page

- Push **S1** button to advance to next page.

|   |            |
|---|------------|
| <b>TELEMETRY</b> <span style="float:right">Y 2/3</span> |            |
| 3 ALTITUDE  | 3 DISTANCE |
| -----   | -----      |
| SBS-01A   | SBS-01G    |
| 3 VARIO   | 3 SPEED    |
| -----   | -----      |
| SBS-01A   | SBS-01G    |

### How to see telemetry date

1. Telemetry screen can be called if the HOME/EXIT button is pushed from the home screen. Or select **[TELEMETRY]** in the Linkage menu and access the setup screen by touching the RTN button.
2. If each item is chosen and the RTN button is pushed, an alarm setup can be performed with the minimum/maximum after a transmitter is turned on.

\*Receiver voltage can be checked immediately. An optional sensor will need to be attached to S.BUS2 of a receiver if you would like to see other information.

\*No special setup is necessary if each sensor displayed is left as in the default setup. Separate sensor ID is also unnecessary. However, if two or more of one kind of sensor is used, setup is required in the "SENSOR" menu.

### ⚠ Warning

- ⊘ Do not watch the transmitter screen during flight.

\*You may lose sight of the aircraft during flight and this is extremely dangerous. Have an assistant on hand to check the screen for you. A pilot should NEVER take his eyes off his aircraft.

# TELEMETRY : Rx-BATT.

Displaying data from the receiver battery voltage

In this screen, the battery voltage of a receiver is displayed.

If it becomes higher or lower than the setting an alarm and/or vibration will alert you.

\*It cannot be used in FASST mode and S-FHSS mode.

\*Only receiver voltage and EXT voltage can be used in FASSTest12CH mode.

\*The FASSTest14CH mode can use all the telemetry functions.

- Select [Rx-BATT.] in the TELEMETRY screen and access the setup screen shown below by touching the RTN button.
- Select the function name and return to the Linkage menu by touching the RTN button. Or the HOME/EXIT button is pushed.
- The maximum and the minimum when powering ON are shown.
- Receiver battery voltage

↓The "down" arrow will indicate that an alarm will sound when the voltage drops to below the setting.

## Alert set

1. Move the cursor to the ↓ALERT [INH] item and touch the RTN button to switch to the data input mode.
  2. Select the ACT mode by scrolling the touch sensor.
  3. Touch the RTN button. (To terminate the input and return to the original state, touch the S1 button.)
  4. Move the cursor to the ↓THRESHOLD [4.0V] item and touch the RTN button to switch to the data input mode.
  5. Adjust the rate by scrolling the touch sensor.  
Initial value: 4.0V  
Adjustment range: 0.0V~8.4V
- \*When the RTN button is touched for one second, the rate is reset to the initial value.
6. Touch the RTN button. (To terminate the input and return to the original state, touch the S1 button.)

## "Vibes" type

If the following types are selected, the transmitter will vibrate during the warning.

- TYPE 1
- TYPE 2
- TYPE 3
- TYPE 4

\*CA-RVIN-700 or SBS-01V must be installed in the aircraft.

The EXT-VOLT screen will display the data from the EXT-battery output from the R7008SB receiver. In order to use this function, it is necessary to connect External voltage connector of the R7008SB receiver to a CA-RVIN-700 (FUTM5551) or SBS-01V to the battery you desire to measure the voltage of.

You will be alerted by an alarm or vibration if the voltage set by you is exceeded.

\*It cannot be used in FASST mode and S-FHSS mode.

\*Only receiver voltage and EXT voltage will be received in the FASSTest12CH mode.

\*The FASSTest14CH mode will display all telemetry data.

- Select [EXT-VOLT] in the TELEMETRY screen and access the setup screen shown below by touching the RTN button.

- Select the function name and return to the Linkage menu by touching the RTN button. Or the HOME/EXIT button is pushed.

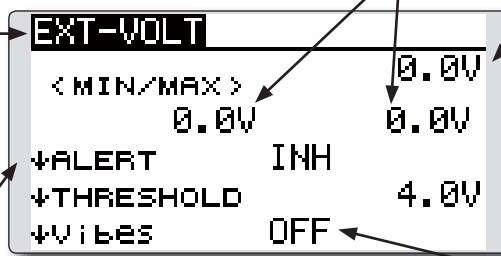

- The maximum and the minimum when powering ON are shown.

- EXT battery voltage

<SensorTouch™>

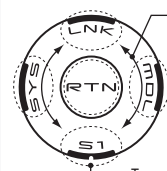

- Scrolling
- Moving cursor
- Selecting mode
- Adjusting value

• To next page

- ↓The arrow will indicate that an alarm will sound when the voltage drops to below the setting.

## Alert set

1. Move the cursor to the ↓ALERT [INH] item and touch the RTN button to switch to the data input mode.
2. Select the ACT mode by scrolling the touch sensor.
3. Touch the RTN button. (To terminate the input and return to the original state, touch the S1 button.)
4. Move the cursor to the ↓THRESHOLD [4.0V] item and touch the RTN button to switch to the data input mode.
5. Adjust the rate by scrolling the touch sensor.  
Initial value: 4.0V  
Adjustment range: 0.0V~100.0V

\*When the RTN button is touched for one second, the rate is reset to the initial value.

6. Touch the RTN button. (To terminate the input and return to the original state, touch the S1 button.)

## "Vibes" type

If the following types are selected, the transmitter will vibrate during the warning.

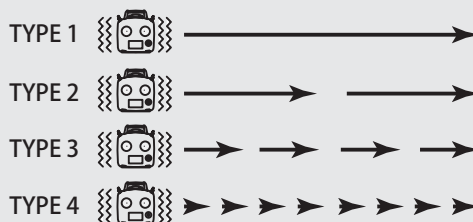

# TELEMETRY : TEMP.

Displaying data from the temperature

**\*A temperature sensor must be installed in the aircraft.**

TEMP. is a screen which displays/sets up the temperature information from an optional temperature sensor.

The temperature of the model (engine, motor, battery etc.) which is flying can be displayed.

If it becomes higher or lower than the setting an alarm and/or vibration will alert you.

\*It cannot be used in FASST mode and S-FHSS mode.

\*Only receiver voltage and EXT voltage can be used in FASSTest12CH mode.

\*The FASSTest14CH mode can use all the telemetry functions.

- Select [TEMP.] in the TELEMETRY screen and access the setup screen shown below by touching the RTN button.
- Select the function name and return to the Linkage menu by touching the RTN button. Or the HOME/EXIT button is pushed.
- The maximum and the minimum when powering ON are shown.
- Temperature
- Scrolling
  - Moving cursor
  - Selecting mode
  - Adjusting value
- Press the S1 button to advance to the next page.
- An upward arrow will show that an alarm will sound when the temperature rises above the set value.
- An downward arrow will show that an alarm will sound when the temperature drops below the set value.

| "Vibes" type  |           |
|---|-----------|
| If the following types are selected, the transmitter will vibrate during the warning. |           |
| TYPE 1  | →         |
| TYPE 2  | → →       |
| TYPE 3  | → → → →   |
| TYPE 4  | → → → → → |

## Alert set : Hot warning

1. Move the cursor to the ↑ALERT item and touch the RTN button to switch to the data input mode.
  2. Select the ACT mode by scrolling the touch sensor.
  3. Touch the RTN button. (To terminate the input and return to the original state, touch the S1 button.)
  4. Move the cursor to the ↑THRESHOLD [+100°C] item and touch the RTN button to switch to the data input mode.
  5. Adjust the rate by scrolling the touch sensor.  
Initial value: +100°C  
Adjustment range: 1°C ~200°C  
(↑THRESHOLD > ↓THRESHOLD)
- \*When the RTN button is touched for one second, the rate is reset to the initial value.
6. Touch the RTN button. (To terminate the input and return to the original state, touch the S1 button.)

## Alert set : Low-temperature warning

1. 2/2 page is accessed by pushing S1. Move the cursor to the ↓ALERT item and touch the RTN button to switch to the data input mode.
  2. Select the ACT mode by scrolling the touch sensor.
  3. Touch the RTN button. (To terminate the input and return to the original state, touch the S1 button.)
  4. Move the cursor to the ↓THRESHOLD [+0 °C] item and touch the RTN button to switch to the data input mode.
  5. Adjust the rate by scrolling the touch sensor.  
Initial value: +0°C  
Adjustment range: 0°C ~199°C  
(↑THRESHOLD > ↓THRESHOLD)
- \*When the RTN button is touched for one second, the rate is reset to the initial value.
6. Touch the RTN button. (To terminate the input and return to the original state, touch the S1 button.)

# TELEMETRY : RPM

Displaying data from the RPM

\*A RPM sensor must be installed in the aircraft.

RPM is a screen which displays / sets up the RPM information from an optional RPM sensor.

The RPM of the model (engine, motor, etc.) which is flying can be shown.

If it becomes higher or lower than the setting an alarm and/or vibration will alert you.

\*It cannot be used in FASST mode and S-FHSS mode.

\*Only receiver voltage and EXT voltage can be used in FASSTest12CH mode.

\*The FASSTest14CH mode can use all the telemetry functions.

- Select [RPM] in the TELEMETRY screen and access the setup screen shown below by touching the RTN button.
- The maximum and the minimum when powering ON are shown.

- Select the function name and return to the Linkage menu by touching the RTN button. Or the HOME/EXIT button is pushed.



- An upward arrow indicates that the alarm will sound when the RPM rises above the set value.

- A downward arrow indicates that the alarm will sound when the RPM falls below the set value.

- "MAGNETIC" or "OPTICAL" is set according to the sensor you use.

SBS-01RM : MAGNETIC  
SBS-01RO : OPTICAL

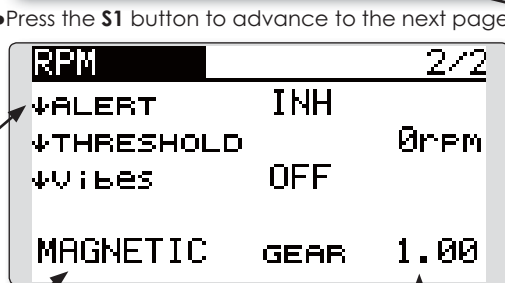
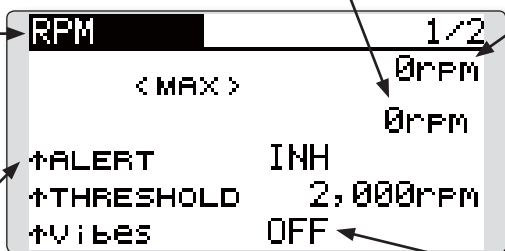

- Press the S1 button to advance to the next page.

- In "MAGNETIC", the gear ratio of your engine (motor) you are using is entered.

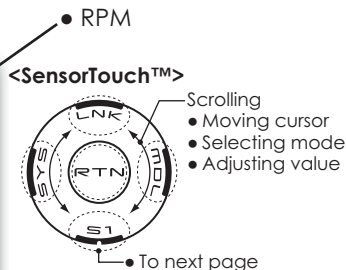

### "Vibes" type

If the following types are selected, the transmitter will vibrate during the warning.

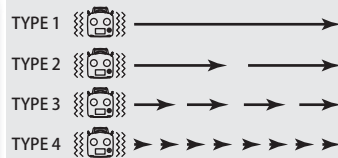

- In "OPTICAL", the number of blades of the propeller (rotor) your model is entered.

### Alert set : Over rotations

1. Move the cursor to the <ALERT> item and touch the RTN button to switch to the data input mode.
  2. Select the ACT mode by scrolling the touch sensor.
  3. Touch the RTN button. (To terminate the input and return to the original state, touch the S1 button.)
  4. Move the cursor to the <THRESHOLD> [2000rpm] item and touch the RTN button to switch to the data input mode.
  5. Adjust the rate by scrolling the touch sensor.  
Initial value: 2000rpm  
Adjustment range: 1rpm~150,000rpm  
(<THRESHOLD> > <THRESHOLD>)
- \*When the RTN button is touched for one second, the rate is reset to the initial value.
6. Touch the RTN button. (To terminate the input and return to the original state, touch the S1 button.)

### Alert set : Under rotations

1. Scroll to the second page by pushing S1. Move the cursor to the <ALERT> item and touch the RTN button to switch to the data input mode.
  2. Select the ACT mode by scrolling the touch sensor.
  3. Touch the RTN button. (To terminate the input and return to the original state, touch the S1 button.)
  4. Move the cursor to the <THRESHOLD> [0rpm] item and touch the RTN button to switch to the data input mode.
  5. Adjust the rate by scrolling the touch sensor.  
Initial value: 0rpm  
Adjustment range: 0rpm~149,999rpm  
(<THRESHOLD> > <THRESHOLD>)
- \*When the RTN button is touched for one second, the rate is reset to the initial value.
6. Touch the RTN button. (To terminate the input and return to the original state, touch the S1 button.)



# TELEMETRY : ALTITUDE

Displaying data from the altitude

**\*An altitude sensor or GPS sensor must be installed in the aircraft.**

ALTITUDE is a screen which displays / sets up the altitude information from an optional altitude sensor or GPS sensor. The altitude of the model which is flying can be known. If it becomes higher (low) than preset altitude, you can be told by alarm. To show warning by vibration can also be chosen. Data when a power supply is turned on shall be 0 m, and it displays the altitude which changed from there. Even if the altitude of an airfield is high, that shall be 0 m and the altitude difference from an

airfield is displayed. This sensor calculates the altitude from atmospheric pressure. Atmospheric pressure will get lower as you go up in altitude, using this the sensor will estimate the altitude. Please understand that an exact advanced display cannot be performed if atmospheric pressure changes in a weather situation.

\*It cannot be used in FASST mode and S-FHSS mode.

\*Only receiver voltage and EXT voltage can be used in FASSTest12CH mode.

\*The FASSTest14CH mode can use all the telemetry functions.

- Select [ALTITUDE] in the TELEMETRY screen and access the setup screen shown below by touching the RTN button.

- Select the function name and return to the Linkage menu by touching the RTN button. Or the HOME/EXIT button is pushed.

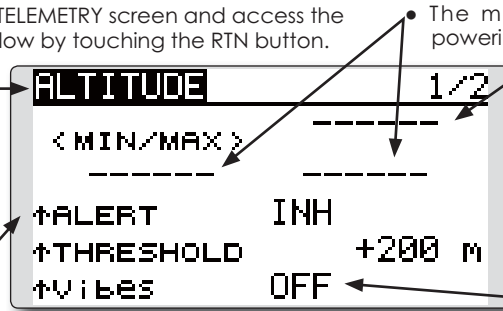

- The maximum and the minimum when powering ON are shown.

- Altitude <SensorTouch™>

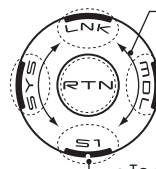

- Scrolling
- Moving cursor
- Selecting mode
- Adjusting value

• To next page

- ↑ An upward arrow indicates the alarm will sound when the altitude reaches above your set value.

- Press the S1 button to advance to the next page.

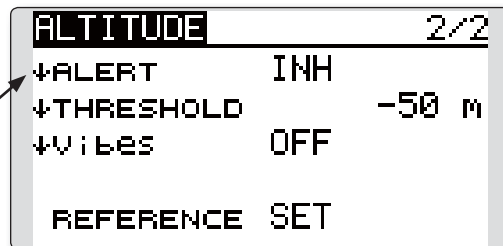

- ↓ An downward arrow indicates the alarm will sound when the altitude reaches below your set value.

**"Vibes" type**

If the following types are selected, the transmitter will vibrate during the warning.

|        |  |             |
|--------|--|-------------|
| TYPE 1 |  | →           |
| TYPE 2 |  | → →         |
| TYPE 3 |  | → → → →     |
| TYPE 4 |  | → → → → → → |

## First, the set of a reference is required.

1. The model and transmitter to which the altitude sensor was connected are turned on.
2. Move the cursor to the [SET] of "REFERENCE" item and touch the RTN button to switch to the data input mode.
3. Touch the RTN button. (To terminate the input and return to the original state, touch the S1 button.)

\*Atmospheric pressure is changed according to the weather also at the same airfield. You should preset before a flight.

## Alert set : High side

1. Move the cursor to the ↑ALERT item and touch the RTN button to switch to the data input mode.
2. Select the ACT mode by scrolling the touch sensor.
3. Touch the RTN button. (To terminate the input and return to the original state, touch the S1 button.)
4. Move the cursor to the ↑THRESHOLD [+200m] item and touch the RTN button to switch to the data input mode.
5. Adjust the rate by scrolling the touch sensor.  
Initial value: +200m  
Adjustment range: -499m~+5,000m  
(↑THRESHOLD > ↓THRESHOLD)

\*When the RTN button is touched for one second, the rate is reset to the initial value.

6. Touch the RTN button. (To terminate the input and return to the original state, touch the S1 button.)

## Alert set : Low side

1. Scroll to the second page by pushing S1. Move the cursor to the ↓ALERT item and touch the RTN button to switch to the data input mode.
2. Select the ACT mode by scrolling the touch sensor.
3. Touch the RTN button. (To terminate the input and return to the original state, touch the S1 button.)
4. Move the cursor to the ↓THRESHOLD [-50m] item and touch the RTN button to switch to the data input mode.
5. Adjust the rate by scrolling the touch sensor.  
Initial value: -50m  
Adjustment range: -500m~+4,999m  
(↑THRESHOLD > ↓THRESHOLD)

\*When the RTN button is touched for one second, the rate is reset to the initial value.

6. Touch the RTN button. (To terminate the input and return to the original state, touch the S1 button.)

# TELEMETRY : VARIO

Displaying data from the variometer

**\*An altitude sensor or GPS sensor must be installed in the aircraft.**

VARIO is a screen which displays / sets up the variometer information from an optional altitude sensor or GPS sensor.

The variometer of the model which is flying can be known.

If it becomes higher or lower than the setting an alarm and/or vibration will alert you.

To ensure that the pilot is aware as to the model's

status, the T14SG incorporates a different melody for ascent and descent. Additionally, depending upon the rate of climb or descent, the tones vary to indicate whether or not the airplane is climbing or descending at a rapid rate.

\*It cannot be used in FASST mode and S-FHSS mode.

\*Only receiver voltage and EXT voltage can be used in FASSTest12CH mode.

\*The FASSTest14CH mode can use all the telemetry functions.

- The maximum and the minimum when powering ON are shown.

- Select [VARIO] in the TELEMETRY screen and access the setup screen shown below by touching the RTN button.
- Select the function name and return to the Linkage menu by touching the RTN button. Or the HOME/EXIT button is pushed.

**VARIO 1/2**

< MIN/MAX >

↑ALERT INH

↑THRESHOLD +0m/s

↑Vibes OFF

**VARIO 2/2**

↑ALERT INH

↓THRESHOLD +0m/s

↑Vibes OFF

MELODY ACT

**"Vibes" type**

If the following types are selected, the transmitter will vibrate during the warning.

|        |  |         |
|--------|--|---------|
| TYPE 1 |  | →       |
| TYPE 2 |  | → →     |
| TYPE 3 |  | → → →   |
| TYPE 4 |  | → → → → |

- Press the S1 button to advance to the next page.
- An upward arrow indicates the alarm will sound when the altitude reaches above your set value.
- A downward arrow indicates the alarm will sound when the altitude reaches below your set value.
- If this is set to ACT, a melody will be activated during the rise or dive, depending on your set values.

## Alert set : Rise side

1. Move the cursor to the ↑ALERT item and touch the RTN button to switch to the data input mode.
  2. Select the ACT mode by scrolling the touch sensor.
  3. Touch the RTN button. (To terminate the input and return to the original state, touch the S1 button.)
  4. Move the cursor to the ↑THRESHOLD [+0m/s] item and touch the RTN button to switch to the data input mode.
  5. Adjust the rate by scrolling the touch sensor.  
Initial value: +0m/s  
Adjustment range: -49m/s~+50m/s  
(↑THRESHOLD > ↓THRESHOLD)
- \*When the RTN button is touched for one second, the rate is reset to the initial value.
6. Touch the RTN button. (To terminate the input and return to the original state, touch the S1 button.)

## Alert set : Dive side

1. Scroll to the second page by pushing S1. Move the cursor to the ↓ALERT item and touch the RTN button to switch to the data input mode.
  2. Select the ACT mode by scrolling the touch sensor.
  3. Touch the RTN button. (To terminate the input and return to the original state, touch the S1 button.)
  4. Move the cursor to the ↓THRESHOLD [+0m/s] item and touch the RTN button to switch to the data input mode.
  5. Adjust the rate by scrolling the touch sensor.  
Initial value: +0m/s  
Adjustment range: -50m/s~+49m  
(↑THRESHOLD > ↓THRESHOLD)
- \*When the RTN button is touched for one second, the rate is reset to the initial value.
6. Touch the RTN button. (To terminate the input and return to the original state, touch the S1 button.)

# TELEMETRY : BATTERY

In this screen, the battery voltage is displayed. In order to use this function, it is necessary to connect External voltage connector of R7008SB ⇔ SBS-01V ⇔ Battery

SBS-01V measures two batteries. The drive battery connected to two lines is displayed on EXT-VOLT. The battery for receivers connected to 3P lines is displayed here.

Displaying data from the battery voltage  
 \*SBS-01V must be installed in the aircraft.

- \*It cannot be used in FASST mode and S-FHSS mode.
- \*Only receiver voltage and EXT voltage can be used in FASSTest12CH mode.
- \*The FASSTest14CH mode can use all the telemetry functions.

- Select [BATTERY] in the TELEMETRY screen and access the setup screen shown below by touching the RTN button.
- Select the function name and return to the Linkage menu by touching the RTN button. Or the HOME/EXIT button is pushed.

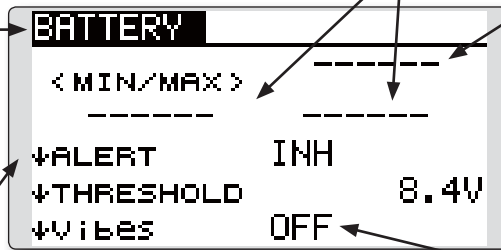

- The maximum and the minimum when powering ON are shown.

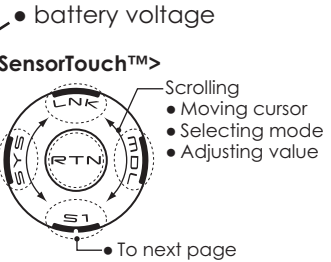

- ↓The arrow will indicate that an alarm will sound when the voltage drops to below the setting.

## Alert set

1. Move the cursor to the ↓ALERT [INH] item and touch the RTN button to switch to the data input mode.
  2. Select the ACT mode by scrolling the touch sensor.
  3. Touch the RTN button. (To terminate the input and return to the original state, touch the S1 button.)
  4. Move the cursor to the ↓THRESHOLD [4.0V] item and touch the RTN button to switch to the data input mode.
  5. Adjust the rate by scrolling the touch sensor.  
 Initial value: 4.0V  
 Adjustment range: 0.0V~8.4V
- \*When the RTN button is touched for one second, the rate is reset to the initial value.
6. Touch the RTN button. (To terminate the input and return to the original state, touch the S1 button.)

## "Vibes" type

If the following types are selected, the transmitter will vibrate during the warning.

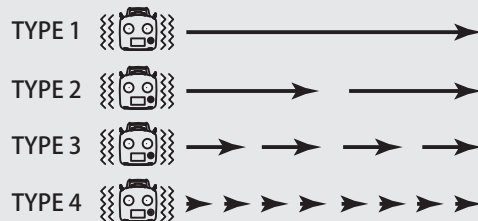

# TELEMETRY : DISTANCE

Displaying data from the distance

\*A GPS sensor must be installed in the aircraft.

Distance is a screen that displays and sets the altitude data from an SBS-01G (GPS Sensor) sold separately. The distance to the airborne aircraft can be read by the transmitter. When the aircraft flies outside (inside) the set distance the operator is alerted by an alarm and vibration.

\*The GPS sensor sold separately is necessary. Mount and connect the sensor in accordance with the sensor instruction manual.

\*It cannot be used in FASST mode and S-FHSS mode.

\*Only receiver voltage and EXT voltage can be used in FASSTest12CH mode.

\*The FASSTest14CH mode can use all the telemetry functions.

- It is the receiving accuracy from a GPS Satellite. Please wait until it becomes 3 displays, and push [REFERENCE].
- Select [DISTANCE] in the TELEMETRY screen and access the setup screen shown below by touching the RTN button.
- Select the function name and return to the Linkage menu by touching the RTN button. Or the HOME/EXIT button is pushed.
- The ↑ arrow shows that an alarm is generated when the set value is exceeded.
- The ↓ arrow shows that an alarm is generated when the distance drops below the set value.
- Press the S1 button to advance to the next page.
- It is the receiving accuracy from a GPS Satellite. Please wait until it becomes 3 displays, and push [REFERENCE].
- Maximum distance after transmitter was turned on.
- Current distance
- Distance alarm setting range 1m ~ 5,000m
- \*Alarm when the aircraft moves far away. (↑THRESHOLD > ↓THRESHOLD)

**"Vibes" type**

If the following types are selected, the transmitter will vibrate during the warning.

|        |  |             |
|--------|--|-------------|
| TYPE 1 |  | →           |
| TYPE 2 |  | → →         |
| TYPE 3 |  | → → → →     |
| TYPE 4 |  | → → → → → → |

## First, the set of a reference is required.

1. The model and transmitter to which the GPS sensor was connected are turned on.
2. It waits until the GPS receiving accuracy displayed on a screen becomes three.
3. Move the cursor to the [SET] of "REFERENCE" item and touch the RTN button to switch to the data input mode.
4. Touch the RTN button. (To terminate the input and return to the original state, touch the S1 button.)

\*Now, the position of the present model was set to 0 m.

4. Move the cursor to the ↓THRESHOLD [1,000m] item and touch the RTN button to switch to the data input mode.
5. Adjust the rate by scrolling the touch sensor.
- \*When the RTN button is touched for one second, the rate is reset to the initial value.
6. Touch the RTN button. (To terminate the input and return to the original state, touch the S1 button.)

## Alert setting when aircraft goes too far

1. Move the cursor to the ↑ALERT item and touch the RTN button to switch to the data input mode.
2. Select the ACT mode by scrolling the touch sensor.
3. Touch the RTN button. (To terminate the input and return to the original state, touch the S1 button.)

## Alert setting when the aircraft approaches

1. Access the second page by pushing S1. Move the cursor to the ↓ALERT item and touch the RTN button to switch to the data input mode.
  2. Select the ACT mode by scrolling the touch sensor.
  3. Touch the RTN button. (To terminate the input and return to the original state, touch the S1 button.)
  4. Move the cursor to the ↓THRESHOLD [0m] item and touch the RTN button to switch to the data input mode.
  5. Adjust the rate by scrolling the touch sensor.  
\*When the RTN button is touched for one second, the rate is reset to the initial value.
  6. Touch the RTN button. (To terminate the input and return to the original state, touch the S1 button.)
- Select [DISTANCE] in the TELEMETRY screen by touching the RTN button. And S1 button is touched twice.

- Select the function name and return to the Linkage menu by touching the RTN button. Or the HOME/EXIT button is pushed.

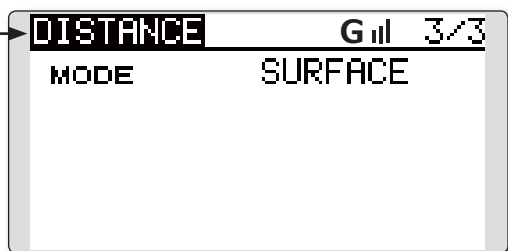

<SensorTouch™>

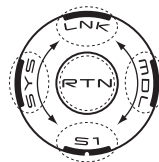

- Altitude calculated as either straight line distance (slant) or surface distance on a map can also be selected (3/3)

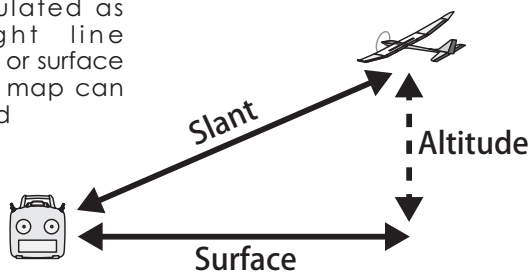

### Two displays methods, straight line distance and surface distance, can be selected as shown above.

1. Select page 3 by touching the S1 button twice from the "DISTANCE" screen.
2. Select <SLANT> <SURFACE> next to "MODE", scroll to the desired method and touch the RTN button.

# TELEMETRY : SPEED

The speed screen displays and sets the speed data from an SBS-01G (GPS sensor) sold separately.

The speed of the aircraft during flight can be displayed.

After flight, the maximum speed during flight can be viewed. Because this speed is based on position data from a GPS satellite, the ground speed

Displaying data from the speed  
 \*A GPS sensor must be installed in the aircraft.

is displayed instead of air speed. Consequently, with a head wind, the displayed speed decreases and with a tail wind, the displayed speed increases.

- \*It cannot be used in FASST mode and S-FHSS mode.
- \*Only receiver voltage and EXT voltage can be used in FASSTest12CH mode.
- \*The FASSTest14CH mode can use all the telemetry functions.

- Select [SPEED] in the TELEMETRY screen and access the setup screen shown below by touching the RTN button.
- Displays the maximum speed after the transmitter is turned on.
- Displays the current speed
- Select the function name and return to the Linkage menu by touching the RTN button. Or the HOME/EXIT button is pushed.
- Press the S1 button to advance to the next page.
- The ↑ arrow shows that an alarm is generated when the speed exceeds the set value.
- The ↓ arrow shows that an alarm is generated when the speed drops below the set value.
- Speed alarm setting range 0 ~ 499km/h (↑THRESHOLD > ↓THRESHOLD)  
 \*Alarm when the speed has decreased.

**<SensorTouch™>**

- Scrolling
- Moving cursor
- Selecting mode
- Adjusting value
- To next page
- Speed alarm setting range 1 ~ 500km/h (↑THRESHOLD > ↓THRESHOLD)  
 \*Alarm when the speed has increased.

**"Vibes" type**

If the following types are selected, the transmitter will vibrate during the warning.

TYPE 1 [Vibe icon] → → → → →

TYPE 2 [Vibe icon] → → → → →

TYPE 3 [Vibe icon] → → → → →

TYPE 4 [Vibe icon] → → → → →

## Alert setting when speed increases

1. Set "↑ALERT" on the <SPEED> screen to ACT. Move the cursor to INH and touch the RTN button.
2. Select the ACT mode by scrolling the touch sensor.
3. Touch the RTN button. (To terminate the input and return to the original state, touch the S1 button.)
4. The speed at which an alarm is generated can be set by selecting the speed display next to "↑THRESHOLD" and touching the RTN button. This generates an alarm when the speed increases.
5. Adjust the rate by scrolling the touch sensor.  
 \*When the RTN button is touched for one second, the rate is reset to the initial value.
6. Touch the RTN button. (To terminate the input and return to the original state, touch the S1 button.)

## Alert setting when speed decreases

1. Select page 2 by pressing S1 from the <SPEED> screen and set "↓ALERT" to ACT.

2. Select the ACT mode by scrolling the touch sensor.
3. Touch the RTN button. (To terminate the input and return to the original state, touch the S1 button.)
4. The speed at which an alarm is generated can be set by selecting the numerical display next to "↓THRESHOLD" and touching the RTN button. This sounds an alarm when the speed decreases.
5. Adjust the rate by scrolling the touch sensor.  
 \*When the RTN button is touched for one second, the rate is reset to the initial value.
6. Touch the RTN button. (To terminate the input and return to the original state, touch the S1 button.)

## \*Speed alarm precaution

Since the GPS speed sensor displays the ground speed, it cannot be used as a stall alarm. For example, an aircraft that stalls at 50km/h will stall if the tailwind is 5km/h or greater even though 55km/h is displayed by ground speed. In addition, with an aircraft that will disintegrate in midflight at 400km/h at an over-speed alarm, when the headwind reaches 30km/h the airplane will disintegrate in midair due to over speeding even at a ground speed of 370km/h.

# SENSOR

## Various telemetry sensors setting

This screen registers the telemetry sensors used with the transmitter. When only one of a certain type of sensor is used, this setting is unnecessary and the sensor can be used by simply connecting it to the S.BUS2 port of the transmitter.

When using 2 or more of the same kind of sensor, they must be registered here.

- Select [SENSOR] in the Linkage menu and access the setup screen shown below by touching the RTN button.

- Select the function name and return to the Linkage menu by touching the RTN button. Or the HOME/EXIT button is pushed.

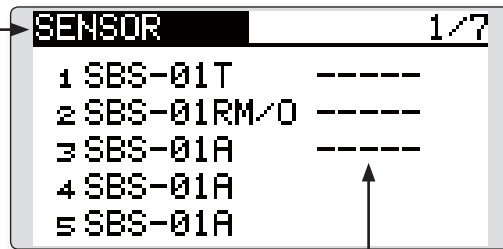

### [What is a slot?]

Servos are classified by CH, but **sensors** are classified in units called “slot”. There are **slots** from **No. 1** to **No. 31**.

**Altitude sensors, GPS sensors** and other data sensor units may use **multiple slots**.

Using a sensor which uses two or more slots, the required number of slots is automatically assigned by setting up a **start slot**.

When 2 or more of the same kind of sensor are used, the sensors themselves must allocate unused slots and memorize that slot.

<SensorTouch™>

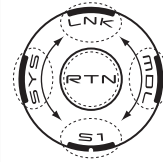

- Sensor ID: When multiple sensors of the same type are not used, ID is unnecessary.

\*3 slots of altitude sensor are used.  
\*8 slots of GPS sensor are used.

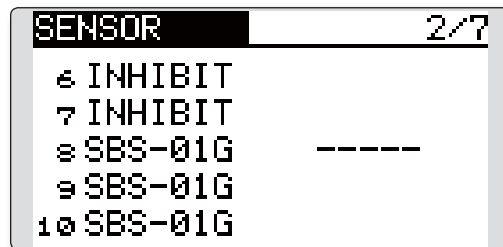

- As shown in the table below, an altimeter requires 3 contiguous slots and a GPS sensor requires 8 contiguous slots. In addition, since the GPS (SBS-01G) start slots are 8, 16, and 24, slots 6 and 7 are inhibited.

< Assignable slot > \*Altimeter, GPS, and other sensors that display a large amount of data require multiple slots.  
\*Depending on the type of sensor, the slot numbers that can be allocated may be limited.

| Sensor                 | The required number of slots | The number which can be used as a start slot                             | Selling area |
|------------------------|------------------------------|--|--------------|
| TEMP (SBS-01T)         | 1 slot                       | 1 ~ 31   | Global       |
| RPM (SBS01RM,SBS-01RO) | 1 slot                       | 1 ~ 31   |              |
| Voltage (SBS-01V)      | 2 slots                      | 1,2,3,4,5,6,8,9,10,11,12,13,14,16,17,18,19,20,21,22,24,25,26,27,28,29,30 |              |
| Altitude (SBS-01A)     | 3 slots                      | 1,2,3,4,5,8,9,10,11,12,13,16,17,18,19,20,21,24,25,26,27,28,29            |              |
| GPS (SBS-01G)          | 8 slots                      | 8,16,24  | Europe       |
| TEMP125-F1713          | 1 slot                       | 1 ~ 31   |              |
| VARIO-F1712            | 2 slots                      | 1,2,3,4,5,6,8,9,10,11,12,13,14,16,17,18,19,20,21,22,24,25,26,27,28,29,30 |              |
| VARIO-F1672            | 2 slots                      | 1,2,3,4,5,6,8,9,10,11,12,13,14,16,17,18,19,20,21,22,24,25,26,27,28,29,30 |              |
| GPS-F1675              | 8 slots                      | 8,16,24  |              |

## SENSOR : RELOAD

This page is set when using multiple telemetry sensors of the same type.

When using multiple sensors of the same type the sensors must be registered in the transmitter. Connect all the sensors to be used to the T14SG as shown in the figure at the right and register them by the following procedure. The ID of each sensor is registered in the transmitter.

- Call page 7 by touching the S1 button 6 times from the [SENSOR] menu.
- Select the function name and return to the Linkage menu by touching the RTN button. Or the HOME/EXIT button is pushed.

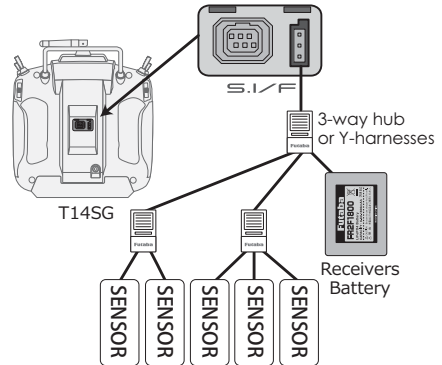
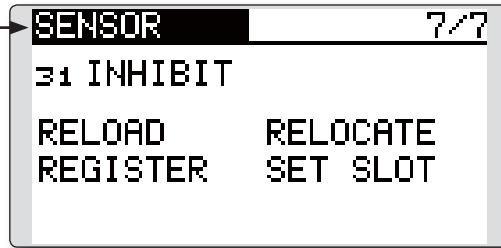

All the sensors to be used are connected.

<SensorTouch™>

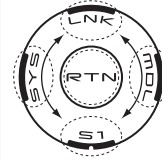

### Reading all the sensors to be used

1. Connect all the sensors and receiver batteries to be used to the T14SG through a hub as shown in the figure above.
2. Move the cursor to "RELOAD" on page 7 of the [SENSOR] screen.
3. Touch the RTN button.  
All the sensors are registered and can be used.

## SENSOR : REGISTER

This page is set when using multiple telemetry sensors of the same type.

This function registers an additional sensor. Connect the sensor as shown in the figure at the right and register it by the following procedure. The sensor ID is registered in the transmitter.

### Additional sensor registration

1. Connect the sensor and receiver battery to be used to the T14SG through a hub as shown in the figure at the right.
2. Move the cursor to "REGISTER" on page 7 of the <Sensor> screen.
3. Touch the RTN button.  
The sensor is registered and can be used.

\*When the number of slots needed in registration is insufficient, an error is displayed and registration cannot be performed. Disable unused slots or perform the following relocate.

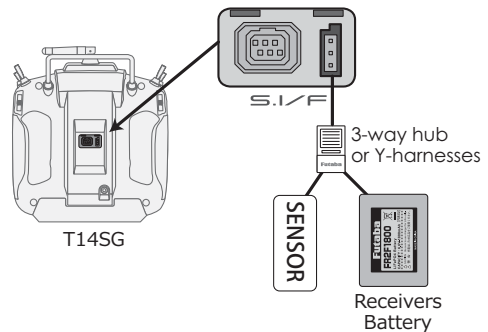



## SENSOR : RELOCATE This page is set when using multiple telemetry sensors of the same type.

This function secures contiguous unused slots by rearranging the registration state when sensor registration and deregistration are performed repeatedly and the unused slots are fragmented.

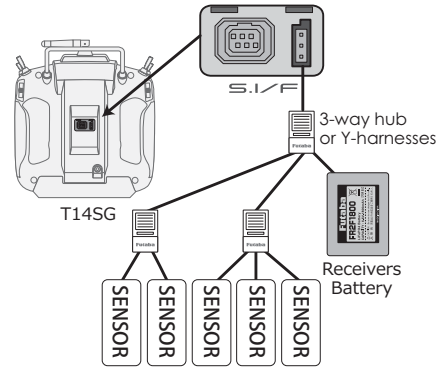

All the sensors to be used are connected.

- Call page 7 by touching the S1 button 6 times from the [SENSOR] menu.

- Select the function name and return to the Linkage menu by touching the RTN button. Or the HOME/EXIT button is pushed.

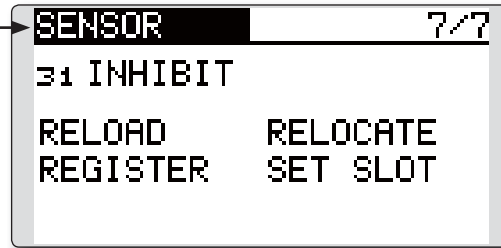

<SensorTouch™>

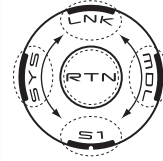

### Relocate of sensors to be used

1. Connect all the sensors and receiver batteries to be used to the T14SG through a hub as shown in the figure above.
2. Move the cursor to "RELOCATE" on page 7 of the [SENSOR] screen.
3. Touch the RTN button.

## SENSOR : SET SLOT This page is set when using multiple telemetry sensors of the same type.

This procedure changes the slot No. of one registered sensor.

### Sensor slot change

1. Connect the sensor and receiver battery to be changed to the T14SG through a hub as shown in the figure above.
2. Move the cursor to "SET SLOT" on page 7 of the <Sensor> screen.
3. Touch the RTN button. A sensor details screen appears.
4. Move the cursor to "LOAD" and touch the RTN button.
5. The current start slot is displayed. Move the cursor to the number of the start slot and change it to the desired value. (Cannot be set to a slot that cannot be allocated like the table of all pages.)
6. Move the cursor to "WRITE" and touch the RTN button.

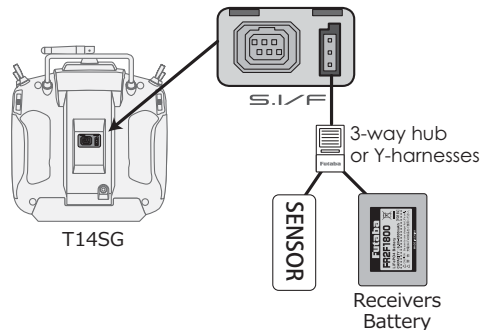

# DATA RESET

Model memory setting data reset.

This function is designed to allow you to reset trim settings or all of the settings saved in the active model memory. You may individually choose to reset the following data;

### T1~T4:

Reset the digital trim setting.

\*The trim step amount and trim rate are not reset.

- Select [DATA RESET] in the Linkage menu and access the setup screen shown below by touching the RTN button.

- Select the function name and return to the Linkage menu by touching the RTN button. Or the HOME/EXIT button is pushed.

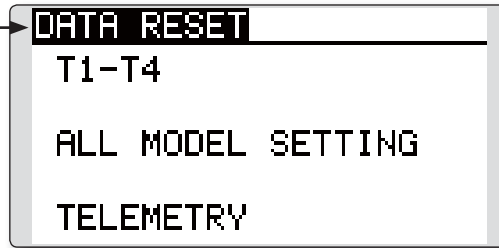

<SensorTouch™>

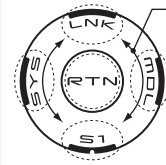

Scrolling  
● Moving cursor

### All model setting:

Resets all Linkage and Model Menu functions except for Frequency, Model Select, Low battery voltage, and Model Type.

\*If the Model Type selected is Glider, the motor function channel is automatically reversed in the Reverse menu; all other channels remain normal.

### TELEMETRY:

Reset the telemetry setting.

## Data resetting method

1. Move the cursor to the item you want to reset and touch the RTN button.  
\*A confirmation message appears.
2. Execute reset by touching the RTN button for one second. (Touch the S1 button to cease resetting.)

[T1-T4]: Resets only the T1-T4

[ALL MODEL SETTING]: Resets all the functions in the Linkage menu and Model menu except the frequency, model select, and model type functions.

[TELEMETRY]: Resets only the telemetry functions.

## MODEL MENU (COMMON FUNCTIONS)

This section describes the D/R, program mixing, and other functions common to all model types.

Before setting the model data, use the Model Type function of the Linkage menu to select the model type matched to the aircraft. If a different model type is selected afterwards, the D/R, program mixing, and other parameters are reset.

If either a helicopter or glider have been selected as the model type, then the specific functions in the Model menu can be set for each flight condition. If you want to switch the settings for each condition by switch, stick position, etc., use the Condition

Select function to add flight conditions. (Up to five conditions can be used)

**Note: The T14SG is designed so that the airplane and glider (including EP glider) model types are compatible with aircraft of similar type wings.**

**This section outlines the relationship between the functions common to airplanes and gliders, except some dedicated functions, and model type.**

**The setting menus will depend on the number of servos and other differences according to the wing type used. The setup screens in the instruction manual are typical examples.**

- Access the model menu shown below by touching the MDL button twice at the home screen, etc.

• Select the function name and return to the Model menu by touching the RTN button. Or a HOME/EXIT button is pushed.

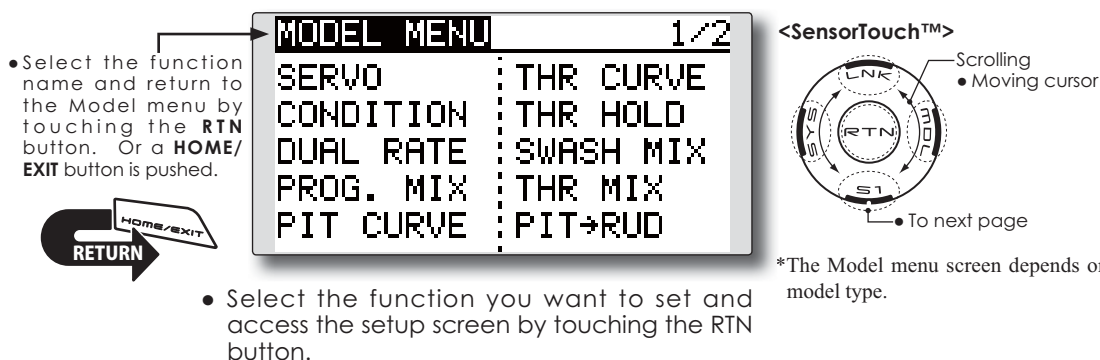

• Select the function you want to set and access the setup screen by touching the RTN button.

\*The Model menu screen depends on the model type.

### Model Menu functions (Common) list

#### •SERVO

Servo test and servo position display (For a description of its functions, see the Linkage Menu section.)

#### •CONDITION (applicable to helicopter and glider selections)

Flight conditions addition, deletion, copy, condition renaming, and condition delay can be set.

#### •DUAL RATE

The D/R curve of a T14SG transmitter may be activated from a switch, stick, position, etc. For

information on how to do so, please refer to the Switch Setting Method located at the back of this manual.

#### •PROG. MIX

The T14SG transmitter allows up to five completely customizable program mixes.

# CONDITION

Flight condition's switch assignment, copy, priority change and condition delay can be set. [except airplane type]

This function, in the Model menu, can be used to switch the settings of up to 5 flight conditions. Please note this is not applicable to airplane type selections.

**Note: To prevent accidental activation of any unused flight conditions during flight, set the switch setting of those unused conditions to null [--].**

- A Condition Delay function can be set. Unnecessary fuselage motion which may be generated when there are sudden changes

in the servo positions and when there are variations in the operating time between channels during condition switching. The delay can be set for each channel to ensure maximum performance from your aircraft.

When setting the delay function for a specific flight condition, the related function changes after a delay corresponding to the set amount.

- If multiple conditions were set, their operational priority may be customized as desired.

- Select [CONDITION] at the Model menu and access the setup screen shown below by touching the RTN button.

(Currently selected condition name)

• Select the function name and return to the Model menu by touching the RTN button. Or the HOME/EXIT button is pushed.

RETURN HOME/EXIT

| CONDITION | NORMAL | 1/3      |
|-----------|--------|----------|
| ▶ NORMAL  |        | PRIORITY |
| IDLEUP1   | SE     | ↑        |
| IDLEUP2   | SE     | ↑ ↓      |
| IDLEUP3   | SF     | ↑ ↓      |
| HOLD      | --     | ↑        |

(Condition name) (Condition switch)

<SensorTouch™>

- Scrolling
- Moving cursor
- Selecting mode
- Adjusting value
- To next page

## Condition switch selection/deletion

1. Move the cursor to the switch item of the condition you want to select/delete and access the switch setup screen by touching the RTN button and select the switch and ON direction.

\*For a detailed description of the setting method, see [Switch Setting Method] at the back of this manual.

Select the copy destination condition by scrolling the touch sensor. Then, touch the RTN button.

\*The current condition can not be selected for the copy destination condition.

3. Move the cursor to the [COPY] item and touch the RTN button. A confirmation message appears.

\*The display blinks.

4. Touch the RTN button for one second and the copying is completed. (Touch the S1 button to stop copying.)

## Condition copy

| CONDITION | NORMAL  | 3/3 |
|-----------|---------|-----|
| DELAY     | SOURCE  |     |
| 09GYR2 0  | NORMAL  |     |
| 10GYR3 0  | ↓ COPY  |     |
| 11AUX1 0  | DESTIN. |     |
| 12AUX1 0  | IDLEUP1 |     |

(Setup screen page 3)

1. Move the cursor to the [SOURCE] item and touch the RTN button to switch to the data input mode.

Select the copy source condition by scrolling the touch sensor. Then, touch the RTN button.

2. Move the cursor to the [DESTIN.] item and touch the RTN button.

## Priority change

1. Move the cursor to the priority up-arrow or down-arrow you want to change and touch the RTN button.

The priority of the corresponding condition is changed. (The last condition becomes the highest priority.)

\*The Normal condition cannot be changed or moved, its priority is always the lowest.

---

## Condition delay setting

---

| CONDITION |   | NORMAL | 2/3 |
|-----------|---|--------|-----|
| DELAY     |   |        |     |
| 1AIL      | 0 | 5GYRO  | 0   |
| 2ELE      | 0 | 6PIT   | 0   |
| 3THR      | 0 | 7GOV   | 0   |
| 4RUD      | 0 | 8NDL   | 0   |

(Setup screen page 2)

1. Select the condition which you want to set.
2. Move the cursor to the "DELAY" icon of the channel you want to set and touch the RTN button to switch to the data input mode.  
Adjust the delay amount by scrolling the touch sensor.  
Initial value: 0  
Adjustment range: 0~27 (maximum delay)
3. Touch the RTN button to end adjustment and return to the cursor mode.

# DUAL RATE The angle and curve of each stick function can be set. [All model types]

Dual rate function is used to adjust the amount of throw and the operational curve of the stick functions (aileron, elevator and rudder) for each flight condition or up to 5 rates for each function. For airplane type, it is also possible to adjust the operational curve of the throttle function.

This is normally used after the End Point programming has been completed to define the maximum throw. When mixing is applied from one channel to another channel, both channels can be adjusted at the same time by adjusting the operation

rate through the dual rate function.

Neutral position of the dual rate curve can be set.

Dual rate curve of FLAP, FLAP3, BUTTERFLY, and CAMBER function can be set. (Airplane/Glider)

\*FLAP3 and BUTTERFLY are glider only functions.

\*EXP rate setting is not allowed in the FLAP, FLAP3, BUTTERFLY, and CAMBER functions.

\*Individual switch setting is not allowed in the FLAP, FLAP3, and BUTTERFLY, CAMBER functions. (Condition switching only)

- Select [DUAL RATE] at the Model menu and access the setup screen shown below by touching the RTN button.

- Function selection

- Select the function name and return to the Model menu by touching the RTN button. Or the HOME/EXIT button is pushed.



- Neutral position

(Currently selected circuit #)

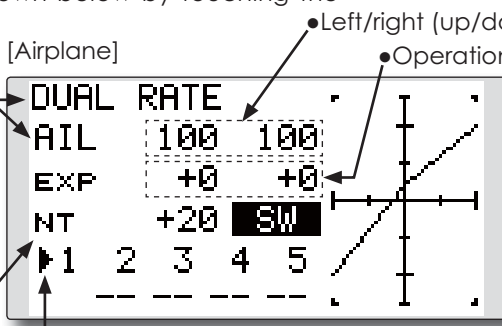

- Switch selection

\*Up to five rates for each function

<SensorTouch™>

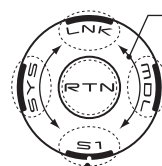

- Scrolling
- Moving cursor
- Selecting mode
- Adjusting value

• To next page

[Helicopter/glider]

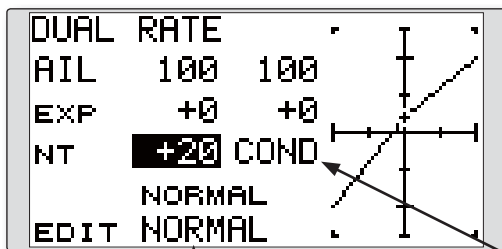

- Condition selection

- Condition Mode selection

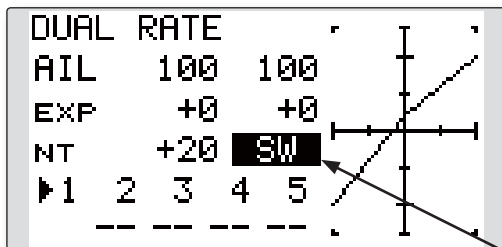

- Switch selection

- Switch mode selection

---

## Dual rate setting procedure

---

### 1. Function selection

Move the cursor to the function selection item and touch the RTN button to switch to the data input mode.

Select the function you want to adjust by scrolling the touch sensor.

Touch the RTN button to the cursor mode.

### 2. Switch selection

Move the cursor to the circuit # item and access the switch setup screen by touching the RTN button. Select the switch activation method and the activation position (if applicable).

\*For a detailed description of the setting method, see [Switch Setting Method] at the back of this manual.

### 3. Left/right (up/down) rate adjustment

\*Perform the settings below after changing to the circuit # or condition you want to adjust.

Move the cursor to the rate item you want to adjust and touch the RTN button to switch to the data input mode.

Adjust the rate by scrolling the touch sensor.

Initial value: 100%

Adjustment range: 0%~140%

\*When the RTN button is touched for one second, the servo operation position is reset to the initial value.)

Touch the RTN button to end the adjustment and return to the cursor mode.

Repeat this procedure for additional rate and other functions as desired.

### 4. Operation curve (EXP curve) adjustment

\*Perform the settings below after changing to the circuit # or condition you want to adjust.

Move the cursor to the EXP item you want to adjust and touch the RTN button to switch to the data input mode.

Adjust the rate by scrolling the touch sensor.

Initial value: 0%

Adjustment range: -100%~+100%

\*When the RTN button is touched for one second, the servo operation position is reset to the initial value.)

\*Using the EXP curve is effective to smoothe or soften the control inputs around center to avoid over-controlling the model. This is often used for the ailerons, elevator and rudder and may be used with the throttle in the case of an airplane selection to smoothe the engine controls as well.

Touch the RTN button to end adjustment and return to the cursor mode.

Repeat this procedure for all other rates and functions as desired.

### 5. Neutral position adjustment

\*Perform the settings below after changing to the circuit # or condition you want to adjust.

Move the cursor to the [NT] item and touch the RTN button to switch to the data input mode.

Adjust the rate by scrolling the touch sensor.

Initial value: 0%

Adjustment range: -100%~+100%

\*When the RTN button is touched for one second, the neutral position is reset to the initial value.)

Touch the RTN button to the cursor mode.

# PROG. MIX

Program mixing which can be freely customized. Up to five mixings can be used for each model. [All model types]

Programmable mixing may be used to correct undesired tendencies of the aircraft, and it may also be used for unusual control configurations. Mixing means that the motion of a command channel, called the "master," is added to the motion of the mixed channel, called "slave."

You may choose to have the Master's trim added to the Slave channel response ("Trim" setting). The mixing

curve (Linear/5-point) can be changed. You may select Mixing ON/OFF switch, control or you may choose to have mixing remaining on all the time.

The Programmable mixing includes a powerful link function, which allows Programmable mixing to be linked with the special mixing functions, or with other programmable mixing functions. The link function can be set up for Master and Slave channel individually.

- Select [PROG. MIX] at the Model menu and access the setup screen shown below by touching the RTN button.

• Select the function name and return to the Model menu by touching the RTN button. Or the HOME/EXIT button is pushed.

• Mix #

**<SensorTouch™>**

- Scrolling
- Moving cursor
- Selecting mode
- Adjusting value
- To next page

**Mix setup screen call**

- Move the cursor to the mix # whose function you want to activate and access the setup screen by touching the RTN button.

• Mixing rate (Left/right, up/down)

[Linear curve]

• Curve selection    • Offset rate (X, Y)

[5-point curve]

• Curve selection    • Point rate (point1-5)

• Current mix No.      • Switch selection

• ON/OFF

• Slave CH      • Link setting

• Master CH      • Trim mode setting

## Prog. mix setting procedure

### • Activate the function.

Move the cursor to the [ACT] item and touch the RTN button to switch to the data input mode.

Select the ACT mode by scrolling the touch sensor.

\*The display blinks.

Touch the RTN button to activate the function and return to the cursor mode.

\*The function is activated. (ON or OFF display)

\*ON/OFF switch and mix rate are not set even though the function is activated.



---

### ●ON/OFF switch setting

Move the cursor to the switch item and access the switch setup screen by touching the RTN button and select the switch and ON direction.

\*For a detailed description of the setting method, see [Switch Setting Method] at the back of this manual.

\*Always on when [--].

### ●Master channel setting

1. Move the cursor to the [MASTER] item and touch the RTN button to switch to the data input mode.

Select the function by scrolling the touch sensor.

\*The display blinks.

Touch the RTN button to change the function and return to the cursor mode.

2. When you want to link this mixing with other mixes, move the cursor to the [LINK] item and touch the RTN button to switch to the data input mode.

Select the link mode, either [+] or [-], by scrolling the touch sensor.

\*The display blinks.

Touch the RTN button to set the link mode and return to the cursor mode.

\*Check to ensure that the link mode is functioning properly by operating the mix accordingly.

\*Master channel control can be set to activate based on the amount of stick input, or VR input, neither of which include ATV, D/R, and mixing selection. In this case, the switch setup screen is displayed by touching the RTN button with "H/W" selected in the function selection. Select master channel control. (To terminate the "H/W" selection, select the [--] display and touch the RTN button.

### ●Slave channel setting

1. Move the cursor to the [SLAVE] item and touch the RTN button to switch to the data input mode.

Select the function by scrolling the touch sensor.

\*The display blinks.

Touch the RTN button to change the function and return to the cursor mode.

2. When you want to link this mixing with other mixes, move the cursor to the [LINK] item and touch the RTN button to switch to the data input mode.

Select the link mode to [+] or [-] by scrolling the touch sensor.

\*The display blinks.

Touch the RTN button to set the link mode and return to the cursor mode.

\*Check the direction by actual operation.

### ●Trim mode ON/OFF setting

1. When changing the trim mode, move the cursor to the [TRIM] item and touch the RTN button to switch to the data input mode.

Select ON/OFF by scrolling the touch sensor.

\*The display blinks.

Touch the RTN button to change the trim mode ON/OFF and return to the cursor mode.

\*To incorporate the mixing from the master trim select [ON]. If trim is not desired, select [OFF].

\*Effective when a function is set in the master channel.

### ●Linear curve setting

[Rate setting]

1. Move the cursor to the mixing rate setting item and touch the RTN button to switch to the data input mode.

Adjust the rate by scrolling the touch sensor.

Initial value: 0%

Adjustment range: -100%~+100%

\*When the RTN button is touched for one second, the servo operation position is reset to the initial value.

Touch the RTN button to end adjustment and return to the cursor mode.

2. Repeat this procedure for all other rates as desired.

[Offsetting the curve horizontally in the vertical or horizontal direction]

1. Move the cursor to the [OFFS] setting item and touch the RTN button to switch to the data input mode.

Adjust the offset rate by scrolling the touch sensor.

Initial value: 0%

Adjustment range: -100%~+100%

\*When the RTN button is touched for one second, the servo operation position is reset to the initial value.)

Touch the RTN button to end the adjustment and return to the cursor mode.

2. Repeat this procedure for the other direction.

### ●5-point curve setting

[Rate setting]

1. Move the cursor to the point rate setting item you want to adjust and touch the RTN button to switch to the data input mode.

Adjust the rate by scrolling the touch sensor.

Initial value: 0%

Adjustment range: -100%~+100%

\*When the RTN button is touched for one second, the servo operation position is reset to the initial value.)

Touch the RTN button to end the adjustment and return to the cursor mode.

2. Repeat this procedure for each point as desired.

# FUEL MIX

Dedicated mixing used to adjust the fuel mixture of applicable engines. [Airplane/helicopter]

This function is utilized to refine in-flight needle adjustments of engines that offer mixture control carburetors.

**Note:** Initial settings does not assign fuel mix to any channel. Prior to utilizing the Fuel Mix settings, select an unused channel on your receiver and assign it accordingly for the mixture control. Additionally, please make sure that your [Control] and [Trim] are set to null [--].

- Select [FUEL MIX] at the Model menu and access the setup screen shown below by touching the RTN button. [Airplane type]

- Select the function name and return to the Model menu by touching the RTN button. Or the HOME/EXIT button is pushed.

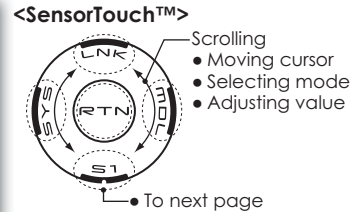
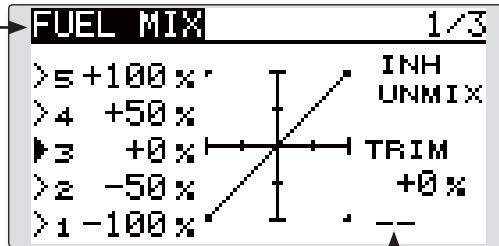

- Needle high trim selection

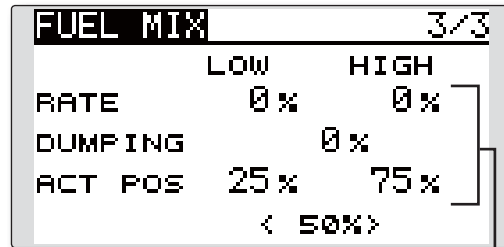
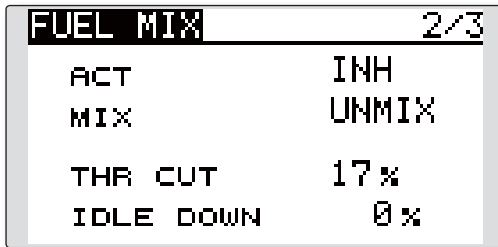

- Acceleration setting

[Helicopter type]

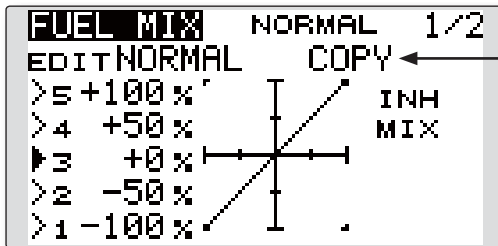

- Mixing curve copy function

Move the COPY item and touch the RTN button to switch to the data input mode. Select the copy destination condition by scrolling the touch sensor and touch the RTN button. Select the [YES] and touch the RTN button.

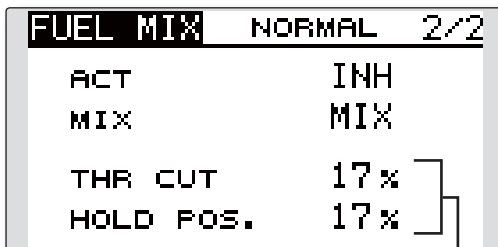

- Engine cut setting

---

## Setting method

---

\*Before using this function, assign the [FUEL MIX] function to an unused channel in the Linkage menu [FUNCTION].

### ●Activate the function.

1. Move the cursor to the [ACT] item and touch the RTN button to switch to the data input mode.

Select the ACT mode by scrolling the touch sensor.

\*The display blinks.

Touch the RTN button to activate the function and return to the cursor mode. (ON is displayed.)

2. Move the cursor to the [MIX] item and touch the RTN button to switch to the data input mode.

Select the mixing mode you want to change by scrolling the touch sensor.

\*The display blinks.

Touch the RTN button to change the mode and return to the cursor mode.

\*When [MIX] is selected at the [MIX] icon, the throttle curve data that is set becomes the mix master. When [UNMIX] is selected, the throttle stick position becomes the master.

### ●5-point curve setting

1. Move the cursor to the point rate setting item you want to adjust and touch the RTN button to switch to the data input mode.

Adjust the rate by scrolling the touch sensor.

Initial value: 0%

Adjustment range: -100%~+100%

\*When the RTN button is touched for one second, the servo operation position is reset to the initial value.)

Touch the RTN button to end adjustment and return to the cursor mode.

2. Repeat this procedure for each point.

### ●Needle high trim setting

1. Move the cursor to the needle high trim selection item and access the switch setup screen by touching the RTN button. Select the needle high trim lever.

\*For a detailed description of the setting method, see [Switch Setting Method] at the back of this manual.

2. Move the cursor to the TRIM rate item and touch the RTN button to switch to the data input mode.

Adjust the trim rate by scrolling the touch sensor.

Initial value: 0%

Adjustment range: -30%~+30%

\*When the RTN button is touched for one second, the rate is

reset to the initial value.)

Touch the RTN button to end adjustment and return to the cursor mode.

\*Needle high trim works as high trim based on the center. (Works like ATL trim.)

### ●Acceleration setting (Airplane)

\*This function is used to adjust the needle/engine rise characteristics during acceleration. This enables an acceleration function which temporarily increases the needle operation from the throttle stick.

This function is used when there are symptoms of the mixture being too lean or too rich, which would be generated by sudden throttle stick inputs.

[Acceleration rate setting (RATE)]

\*Acceleration can be adjusted for both high and low settings.

[Damping rate setting (DUMPING)]

\*The return time after operation (Dumping) can be set.

Move the cursor to the rate item you want to change and touch the RTN button to switch to the data input mode.

Adjust the rate by scrolling the touch sensor.

\*When the RTN button is touched for one second, the rate is reset to the initial value.)

Touch the RTN button to end adjustment and return to the cursor mode.

[Operation point setting (ACT POS)]

\*The operation point at which the acceleration setting will occur. If this point is exceeded, acceleration is performed.

Move the cursor to the [ACT POS] item and hold the throttle stick to the position you want to change and touch the RTN button for one second.

**Note: When using the acceleration function, since the needle stroke is large, adjust your settings so there is no binding of your linkage.**

### ●Engine cut setting

\*Operation linked with the throttle hold function, throttle cut function, and idle down function is possible. The throttle cut position can be adjusted accordingly. Set it to the full closed position.

Move the cursor to the throttle cut or idle down item and touch the RTN button to switch to the data input mode.

Adjust the servo position by scrolling the touch sensor.

Initial value: THR CUT: 17%, IDLE DOWN: 0%

Adjustment range: THR CUT: 0~50%, IDLE DOWN: 0~100%

\*When the RTN button is touched for one second, the rate is reset to the initial value.)

Touch the RTN button to end the adjustment and return to the cursor mode.

# MODEL MENU (AIRPLANE/GLIDER FUNCTIONS)

The dedicated mixes, etc. that are applicable when an airplane or glider model type is selected are displayed in this Model menu functions section. Prior to adjusting any of these mixes, etc. use the Model Type function in the Linkage menu to select the model type, wing type, and tail type matched to the aircraft. Other settings reset the data used in mixing function, etc.

For glider, many dedicated mixes can be set for each flight condition, as required. To switch the settings for each condition by switch or stick

position, use the Condition Select function to add flight conditions. (Up to five conditions can be used)

Note: The T14SG is designed so that the airplane and glider model types can utilize aircraft of the same wing type.

The functions common to airplanes and gliders, with the exception of some dedicated functions, are written without regard to the model type.

While there may be differences, depending on the number of servos, etc. the wing type used, etc. the setup screens in the instruction manual are typical examples.

- Access the model menu shown below by touching the MDL button twice at the home screen, etc.

\*The Model menu screen depends on the model type.

- Select the function name and return to the Model menu by touching the RTN button. Or a HOME/EXIT button is pushed.

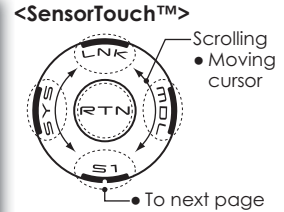
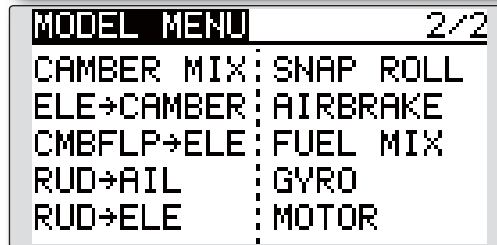
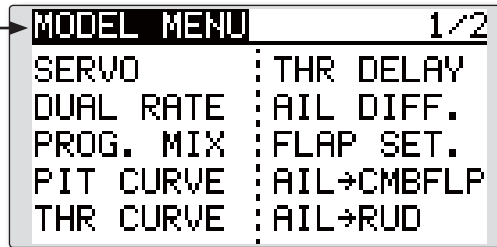

- Select the function you want to set and access the setup screen by touching the RTN button.

## Model Menu functions list

### PITCH CURVE

Compatible with VPP (Variable Pitch Propeller) function. [Airplane, general]

### THR CURVE

THR curve function adjusts the throttle operation curve for optimum engine speed to throttle stick movement. [Airplane/glider, general]

### THR DELAY

THR-DELAY function is used to slow the response of the throttle stick to simulate the slow response of a turbine engine, etc. [Airplane, general]

### AIL DIFFERENTIAL

The left and right aileron differential can be adjusted independently. For glider, the differential

rate in butterfly mixing can be adjusted.

[Airplane/glider, 2 ailerons or more]

### FLAP SETTING

The up/down travel of each flap can be adjusted independently for each servo according to the wing type. [Airplane/glider, 2 flaps or more]

### AIL to CAMB.FLP

This mix operates the camber flaps in the aileron mode. It improves the roll axis characteristics. [Airplane/glider, 2 ailerons + 2 flaps or more]

### AIL to BRKFLP

This mix operates the brake flaps in the aileron mode. It improves the roll axis characteristics. [Glider, 4 flaps]

---

## AIL to RUD

This mix is used when you want to coordinate the rudder with aileron operation for banking at shallow angles. [Airplane/glider, general]

## RUD to AIL

This function is used when you want to mix the ailerons with rudder input. Rudder is applied during rolling maneuvers such as knife edge flight. [Airplane/glider, general]

## CAMBER MIX

This mix adjusts the camber and corrects the elevators. [Airplane/glider, 2 ailerons or more]

## ELE to CAMBER

This mix is used when you want to mix the camber flaps with elevator to increase the lift of the model. [Airplane/glider, 2 ailerons or more]

## CAMB.FLP to ELE

This mix is used to correct for changes in attitude when the camber flaps are utilized. [Airplane/glider, 2 ailerons + 1 flap or more]

## BUTTERFLY (Crow)

This function is used to quickly slow the aircraft and/or reduce the altitude. [Glider, 2 ailerons or more (Flying: 2 ailerons + 1 flap or more)]

## TRIM MIX

The ailerons, elevators, and flaps trim offset rate can be accessed by selecting a switch or condition selection as desired. [Glider, 2 ailerons or more]

## AIRBRAKE

This function is used when airbrakes are necessary when landing or when diving, etc. during flight. (Airplane, 2 ailerons or more)

## GYRO

This is a dedicated mix when a GYA Series gyro is used. [Airplane/glider, general]

## V-TAIL

This function incorporates the elevators and rudder input for use with V-tail models. [Airplane/glider, V-tail specifications]

## AILEVATOR (DUAL ELEVATOR)

This function adjusts the elevators and ailerons of models with elevator specifications. [Airplane/glider, ailevator specifications]

## WINGLET

This function adjusts the left and right rudders of winglet models. [Airplane/glider, winglet specifications]

## MOTOR

This function adjusts the operation speed when the motor of an F5B or other such EP glider is started by a switch. [Airplane/glider, general]

## RUD to ELE

This function is used to correct rolling maneuvers such as, knife edge flight. [Airplane, general]

## SNAP ROLL

This function selects the snap roll switch and adjusts the amount of servo input. Servo speed can also be adjusted. [Airplane general]

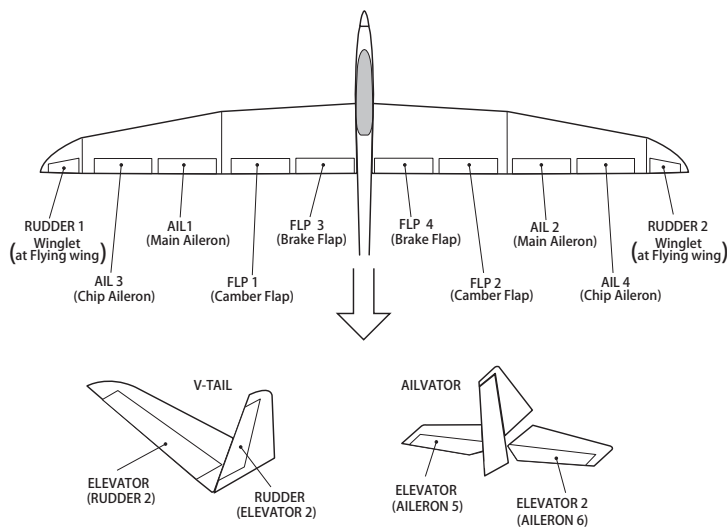

This function adjusts the pitch curve for VPP (Variable Pitch Propeller) airplane.

- \*Up to 3 conditions can be set.
- \*The priority increases in condition 1→2→3 order.

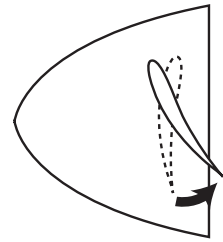

- Select [PIT CURVE] at the Model menu and access the setup screen shown below by touching the RTN button.

**NOTE: When VPP is not assigned to any channel, the pitch curve is not displayed in the model menu. In this case, assign VPP to any channel on the function screen.**

- Select the function name and return to the Model menu by touching the RTN button. Or the HOME/EXIT button is pushed.

**PIT CURVE # 1**

|    |      |       |  |
|----|------|-------|--|
| >5 | +100 | (100) |  |
| >4 | +50  | 75.0  |  |
| >3 | +0   | 50.0  |  |
| >2 | -50  | 25.0  |  |
| ▶1 | -100 | ( 0 ) |  |

•Curve rate
•Curve point

<SensorTouch™>

- Scrolling
- Moving cursor
- Selecting mode
- Adjusting value
- To next page

## Setting method

### •VPP condition selection

1. Move the cursor to the # button at the top right side of the screen and touch the RTN button to switch to the data input mode. Select the VPP condition by scrolling the touch sensor.

\*The display blinks.

Touch the RTN button to call the setting screen and return to the cursor mode.

2. Move the cursor to the switch item and touch the RTN button to access the selection screen. Select the switch and set its ON direction.

\*For a description of the switch selection method, see the description at the back of this manual.

Set the VPP condition 2 and 3 switch.

\*The VPP conditions can also be checked in the HOME screen.

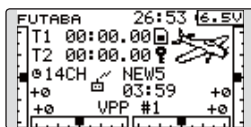

### •5-point curve setting

[Curve rate setting]

1. Move the cursor to the curve rate setting item you want to adjust and touch the RTN

button to switch to the data input mode.

Adjust the rate by scrolling the touch sensor. Initial value: 0%

Adjustment range: 0%~100%

\*When the RTN button is touched for one second, the rate is reset to the initial value.

Touch the RTN button to end the adjustment and return to the cursor mode.

2. Repeat this procedure for each point. [Moving curve point]

1. Move the cursor to the curve point setting item you want to adjust and touch the RTN button to switch to the data input mode.

Adjust the curve point by scrolling the touch sensor.

Initial value: P1: (0%), P2: 25%, P3: 50%, P4: 75%, P5: (100%)

Adjustment range: Up to 2.5% in front of the adjoining point

\*When the RTN button is touched for one second, the curve position is reset to the initial value.)

Touch the RTN button to end the adjustment and return to the cursor mode.

2. Repeat this procedure for each point.

[Deleting/returning curve point]

Move the cursor to the curve point setting item you want to delete/return and touch the RTN button for one second.

This function adjusts the throttle curve for optimum engine speed from throttle stick input.

\*When throttle curve is set to ON when there is no throttle function; this curve acts as the motor function.

- Select [THR CURVE] at the Model menu and access the setup screen shown below by touching the RTN button.

**NOTE: If this throttle curve function is activated, you can not use the THR-EXP function within the DUAL RATE function simultaneously.**

• Select the function name and return to the Model menu by touching the RTN button. Or the HOME/EXIT button is pushed.

• Curve rate      • Curve point

<SensorTouch™>

- Scrolling
- Moving cursor
- Selecting mode
- Adjusting value

• To next page

## Setting method

### • Activate the function.

1. Move the cursor to the [ACT] item and touch the RTN button to switch to the data input mode.

Select the ON mode by scrolling the touch sensor.

\*The display blinks.

Touch the RTN button to activate the function and return to the cursor mode.

### • 5-point curve setting

[Curve rate setting]

1. Move the cursor to the curve rate setting item you want to adjust and touch the RTN button to switch to the data input mode.

Adjust the rate by scrolling the touch sensor.

Initial value: 0%

Adjustment range: 0%~100%

\*When the RTN button is touched for one second, the rate is reset to the initial value.)

Touch the RTN button to end the adjustment and return to the cursor mode.

2. Repeat this procedure for each point.

[Moving curve point]

1. Move the cursor to the curve point setting

item you want to adjust and touch the RTN button to switch to the data input mode.

Adjust the curve point by scrolling the touch sensor.

Initial value: P1: (0%), P2: 25%, P3: 50%, P4: 75%, P5: (100%)

Adjustment range: Up to 2.5% in front of the adjoining point

\*When the RTN button is touched for one second, the curve position is reset to the initial value.)

Touch the RTN button to end the adjustment and return to the cursor mode.

2. Repeat this procedure for each point.

[Deleting/returning curve point]

Move the cursor to the curve point setting item you want to delete/return and touch the RTN button for one second.

THR-DELAY function is used to slow the response of the throttle stick to simulate the slow response of a turbine engine, etc.

\*This function is the same as THR of servo speed. If it sets up in great numbers, it overlaps and a THR servo becomes late further. Please do not let me overlap. Use either.

- Select [THR DELAY] at the Model menu and access the setup screen shown below by touching the RTN button.



## Setting method

### ● Operation speed (delay) setting

1. Move the cursor to the [DELAY] item and touch the RTN button to switch to the data input mode.

Adjust the delay rate by scrolling the touch sensor.

Initial value: 0

Adjustment range: 0~27 (maximum delay)

\*When the RTN button is touched for one second, the rate is reset to the initial value.)

Touch the RTN button to activate the function and return to the cursor mode.



# AIL DIFF.

[Corresponding model type]: Airplane/glider, 2 ailerons or more

The left and right aileron differential can be adjusted independently.

For glider, the differential rate in butterfly mixing can be adjusted.

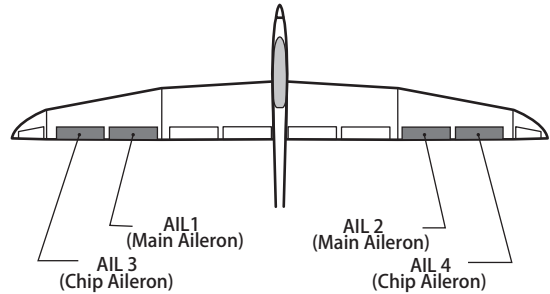

\*The display screen is an example. The actual screen depends on the Model Type.

- Select [AIL DIFF.] at the Model menu and access the setup screen shown below by touching the RTN button.

[Airplane (2A+2F)]

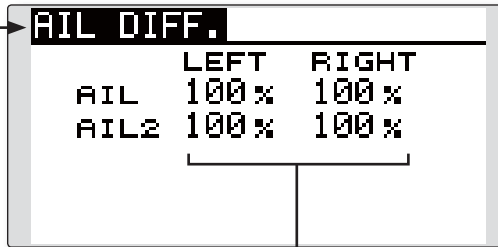

- Select the function name and return to the Model menu by touching the RTN button. Or the HOME/EXIT button is pushed.



- Aileron left/right adjustment

<SensorTouch™>

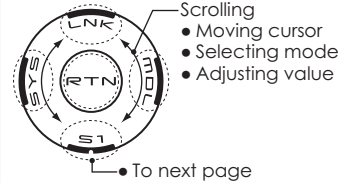

[Glider (4A+2F)]

(Currently selected condition name)

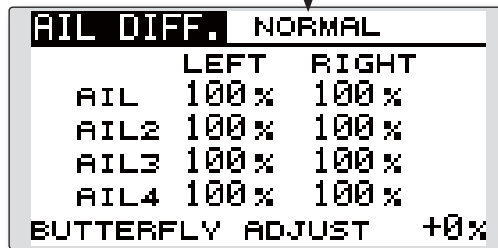

## Setting method

### •Aileron left/right adjustment

Move the cursor to the aileron (AIL) 1~4 left (or right) setting item and touch the RTN button to switch to the data input mode.

Adjust the aileron angles by scrolling the touch sensor when the stick is moved to the left (or right) end.

Initial value: 100%

Adjustment range: 0~120%

\*When the RTN button is touched for one second, the rate is reset to the initial value.)

Touch the RTN button to end the adjustment and return to the cursor mode.

### •Aileron differential adjustment in butterfly mixing

Move the cursor to the [BUTTERFLY ADJUST] item and touch the RTN button to switch to the data input mode.

Adjust the differential rate by scrolling the touch sensor.

Initial value: 0%

Adjustment range: -120~+120%

\*When the RTN button is touched for one second, the rate is reset to the initial value.)

Touch the RTN button to end the adjustment and return to the cursor mode.

# FLAP SET.

[Corresponding model type]: Airplane/glider, 2 flaps or more

The up/down travel of each flap (camber flaps: FLP1/2, brake flaps: FLP3/4) can be adjusted independently for each servo according to the wing type.

- The operation reference point of each flap can be offset

The camber flaps of a 4-flap model can be mixed with the brake flaps. (BRKFLP to CMBFLP)

- An ON/OFF switch can be set.
- Select [FLAP SET.] at the Model menu and access the setup screen shown below by touching the RTN button.

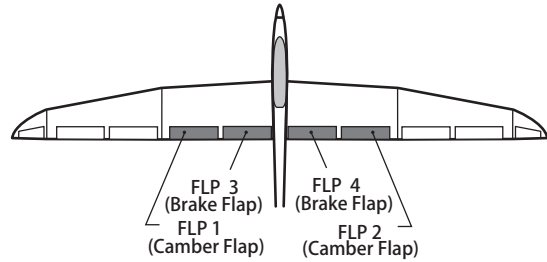

\*The display screen is an example. The actual screen depends on the model type.

• Select the function name and return to the Model menu by touching the RTN button. Or the HOME/EXIT button is pushed.

• Up /Down adjustment      • Operation reference point offset

**<SensorTouch™>**

- Scrolling
- Moving cursor
- Selecting mode
- Adjusting value

• To next page

(Glider: Currently selected condition name)

## Setting method

### • Flap up/down adjustment

Move the cursor to the flap (FLP) 1~4 Up or Down item according to the wing type and touch the RTN button to switch to the data input mode. Adjust the travel independently by scrolling the touch sensor.

Initial value: +100%

Adjustment range: -120~+120%

\*When the RTN button is touched for one second, the rate is reset to the initial value.)

Touch the RTN button to end the adjustment and return to the cursor mode.

### • Reference point adjustment

Move the cursor to the [OFFSET] item and touch the RTN button to switch to the data input mode. Adjust the operation reference point of each flap by scrolling the touch sensor.

Initial value: 0%

Adjustment range: -100~+100%

\*When the RTN button is touched for one second, the reference point is reset to the initial value.)

Touch the RTN button to end the adjustment and return to the cursor mode.

### • Activate the Brake FLP to Camber FLP mixing

Move the cursor to the [ACT] item and touch the RTN button to switch to the data input mode. Select the ACT mode by scrolling the touch sensor.

\*The display blinks.

Touch the RTN button to activate the function and return to the cursor mode. (ON is displayed.)

To select a switch, move the cursor to the [SW] item and touch the RTN button to call the selection screen. Select the switch and set its ON direction. (Always ON at "--" setting)

\*For a description of the switch selection method, see the description at the back of this manual.

## AIL to CMBFLP

[Corresponding model type]: Airplane/glider, 2 ailerons + 2 flaps or more

This mix operates the camber flaps (FLP1/2) in the aileron mode. When the aileron stick is manipulated, the ailerons and camber flaps perform aileron operation simultaneously to significantly improve the roll axis.

- The aileron left/right mixing rate of each flap servo can be independently adjusted.
- An ON/OFF switch can be set.
- Linking is possible: Link this mix to other mixes.

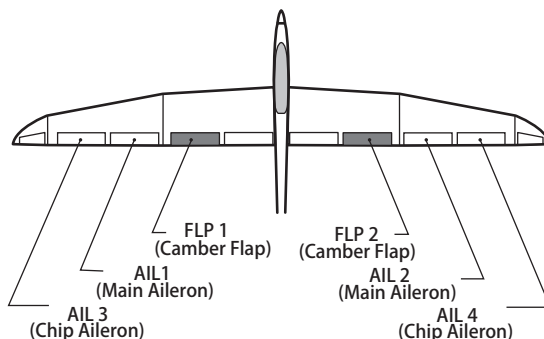

\*The display screen is an example. The actual screen depends on the model type.

- Select [AIL to CMBFLP] at the Model menu and access the setup screen shown below by touching the RTN button.

- Select the function name and return to the Model menu by touching the RTN button. Or the HOME/EXIT button is pushed.

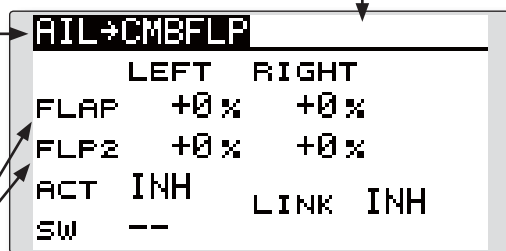

<SensorTouch™>

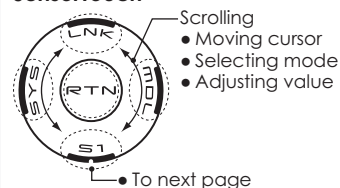

- Adjustment of each flap servo

### Setting method

#### •Activate the function

Move the cursor to the [ACT] item and touch the RTN button to switch to the data input mode. Select the ACT mode by scrolling the touch sensor.

\*The display blinks.

Touch the RTN button to activate the function and return to the cursor mode. (ON is displayed.)

When selecting a switch, move the cursor to the [SW] item and touch the RTN button to call the selection screen. Select the switch and set its ON direction. (Always ON at "--" setting)

\*For a description of the switch selection method, see the description at the back of this manual.

#### •Mixing rate adjustment

Move the cursor to the flap (FLP) 1~2 left or right item according to the wing type and touch the RTN button to switch to the data input mode. Adjust the mixing rate

independently by scrolling the touch sensor.

Initial value: 0%

Adjustment range: -120~+120%

\*When the RTN button is touched for one second, the rate is reset to the initial value.)

Touch the RTN button to end the adjustment and return to the cursor mode.

#### •Link mode setting

When linking a mix, move the cursor to the [LINK] item and touch the RTN button to switch to the data input mode. Select the ON mode by scrolling the touch sensor.

\*The display blinks.

Touch the RTN button to set the link mode and return to the cursor mode.

# AIL to BRAKEFLP

[Corresponding model type]: Glider, 4 flaps

This mix operates the brake flaps (FLP3/4) in the aileron mode. When the aileron stick is manipulated, the aileron and brake flaps perform the aileron operation simultaneously and the roll axis is improved.

- The aileron left and right mixing rates can be adjusted separately for each flap servo.
- Mixing during flight can be turned ON/OFF by setting a switch. (Always ON at [-] setting)
- Linking can be set: Link this mix to other mixes.

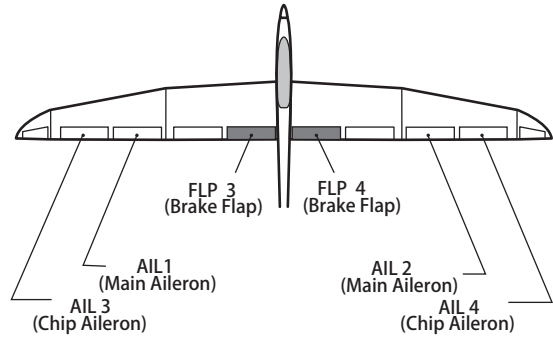

\*The display screen is an example. The actual screen depends on the model type.

- Select [AIL to BRKFLP] at the Model menu and access the setup screen shown below by touching the RTN button.

- Select the function name and return to the Model menu by touching the RTN button. Or the HOME/EXIT button is pushed.

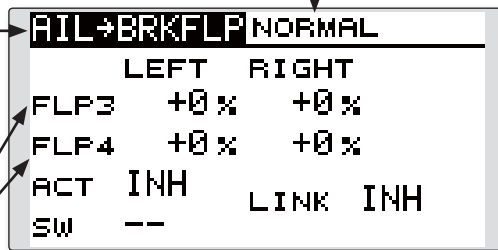

<SensorTouch™>

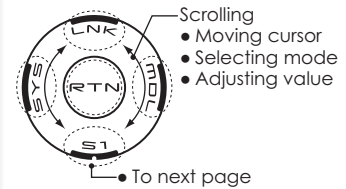

- Adjustment of each flap servo

## Setting method

### • Activate the function

Move the cursor to the [ACT] item and touch the RTN button to switch to the data input mode. Select the ACT mode by scrolling the touch sensor.

\*The display blinks.

Touch the RTN button to activate the function and return to the cursor mode. (ON is displayed.)

When setting a switch, move the cursor to the [SW] item and touch the RTN button to access the selection screen. Select the switch and set its ON direction. (Always ON at "-" setting)

\*For a description of the switch selection method, see the description at the back of this manual.

### • Mixing rate adjustment

Move the cursor to the flap (FLP) 3~4 left or right item and touch the RTN button to switch to the data input mode. Adjust the mixing rate independently by scrolling the touch

sensor.

Initial value: 0%

Adjustment range: -120~+120%

\*When the RTN button is touched for one second, the rate is reset to the initial value.)

Touch the RTN button to end the adjustment and return to the cursor mode.

### • Link mode setting

To activate the mixing, move the cursor to the [LINK] item and touch the RTN button to switch to the data input mode. Select the ON mode by scrolling the touch sensor.

\*The display blinks.

Touch the RTN button to set the link mode and return to the cursor mode.

Use this mix when you want to mix the rudders with aileron operation. This allows the aircraft to bank at a steep angle.

- Mixing during flight can be turned ON/OFF by a switch. (Always ON at [-] setting)
- The mixing rate can be adjusted.

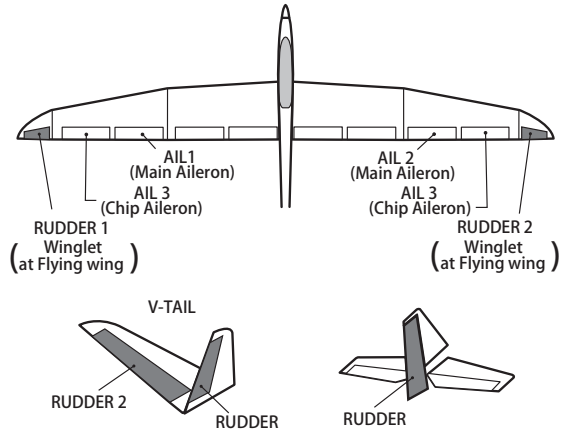

- Select [AIL to RUD] at the Model menu and access the setup screen shown below by touching the RTN button.

(Glider: Currently selected condition name)

- Select the function name and return to the Model menu by touching the RTN button. Or the HOME/EXIT button is pushed.

**AIL→RUD**

LEFT    RIGHT

  +0%    +0%

ACT   INH

SW    --

<SensorTouch™>

• To next page

\*The display screen is an example. The actual screen depends on the model type.

## Setting method

### •Activate the function

Move the cursor to the [ACT] item and touch the RTN button to switch to the data input mode. Select the ACT mode by scrolling the touch sensor.

\*The display blinks.

Touch the RTN button to activate the function and return to the cursor mode. (ON is displayed.)

When selecting a switch, move the cursor to the [SW] item and touch the RTN button to call the selection screen. Select the switch and set its ON direction. (Always ON at "--" setting)

\*For a description of the switch selection method, see the description at the back of this manual.

### •Mixing rate adjustment

Move the cursor to the left or right item and touch the RTN button to switch to the data input mode. Adjust the mixing rate independently by scrolling the touch sensor.

Initial value: 0%

Adjustment range: -100~+100%

\*When the RTN button is touched for one second, the rate is reset to the initial value.)

Touch the RTN button to end the adjustment and return to the cursor mode.

# RUD to AIL

[Corresponding model type]: Airplane/glider, general

This function is used when you want to mix the ailerons with rudder input. It is used when rudder is applied during roll maneuvers such as, knife edge flight. It can be used to turn or bank scale models, large models, etc. like a full-size aircraft.

- Mixing during flight can be turned ON/OFF by setting a switch. (Always ON at [-] setting)
- Linking can be set: Link this mix to other mixes.
- The mixing rate can also be adjusted.
- A 5-point curve can be set at airplane model type.

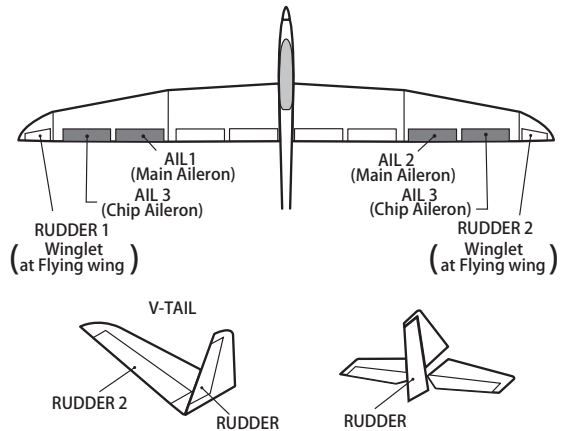

- Select [RUD to AIL] at the Model menu and access the setup screen shown below by touching the RTN (Glider: Currently selected condition name) button.

- Select the function name and return to the Model menu by touching the RTN button. Or the HOME/EXIT button is pushed.

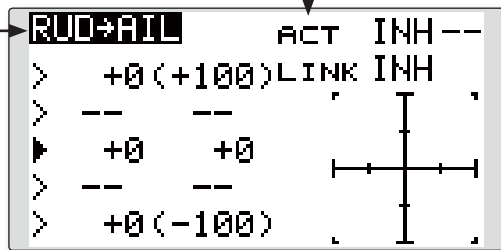

<SensorTouch™>

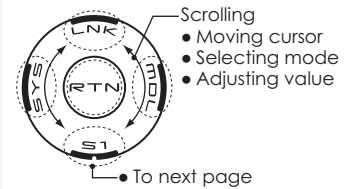

\*The display screen is an example. The actual screen depends on the model type.

## Setting method

### • Activate the function

Move the cursor to the [ACT] item and touch the RTN button to switch to the data input mode. Select the ACT mode by scrolling the touch sensor.

\*The display blinks.

Touch the RTN button to activate the function and return to the cursor mode. (ON is displayed.)

When setting a switch, move the cursor to the [SW] item and touch the RTN button to call the selection screen. Select the switch and set its ON direction. (Always ON at "--" setting)

\*For a description of the switch selection method, see the description at the back of this manual.

### • Mixing rate adjustment (glider)

Move the cursor to the left or right item and touch the RTN button to switch to the data input mode. Adjust the mixing rate independently by scrolling the touch sensor.

Initial value: 0%

Adjustment range: -100~+100%

\*When the RTN button is touched for one second, the rate is reset to the initial value.)

Touch the RTN button to end the adjustment and return to the cursor mode.

### • Link mode setting

To activate the link mixing, move the cursor to the [LINK] item and touch the RTN button to switch to the data input mode. Select the ON mode by scrolling the touch sensor.

\*The display blinks.

Touch the RTN button to set the link mode and return to the cursor mode.

---

## ●5-point curve setting (airplane)

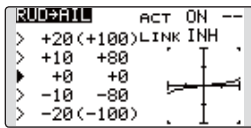

[Curve rate setting]

1. Move the cursor to the curve rate setting item (left side) you want to adjust and touch the RTN button to switch to the data input mode.

Adjust the rate by scrolling the touch sensor.

Adjustment range: -100%~+100%

\*When the RTN button is touched for one second, the rate is reset to the initial value.)

Touch the RTN button to end the adjustment and return to the cursor mode.

2. Repeat this procedure for each point.

[Moving curve point]

1. Move the cursor to the curve point setting item you want to adjust and touch the RTN button to switch to the data input mode.

Adjust the curve point by scrolling the touch sensor.

Adjustment range: Up to 2.5% in front of the adjoining point

\*When the RTN button is touched for one second, the curve position is reset to the initial value.)

Touch the RTN button to end the adjustment and return to the cursor mode.

2. Repeat this procedure for each point.

[Deleting/returning curve point]

Move the cursor to the curve point setting item you want to delete/return and touch the RTN button for one second.

# CAMBER MIX

[Corresponding model type]: Airplane/glider, 2 ailerons or more

This function adjusts the rate of camber operation for the wing camber (ailerons, camber flaps, brake flaps) in the negative and positive directions. The aileron, flap, and elevator rates can also be adjusted independently and attitude changes caused by camber operation can be corrected.

- Select [CAMBER MIX] at the Model menu and access the setup screen shown below by touching the RTN button.

- \*Initial setting assigns camber operation to side lever LS.
- The up/down rates of the aileron, flap, and elevator servos can be adjusted. When the mixing direction is reversed by the linkage, adjustments can be made by changing the mixing rate polarity (+ or -).
- Mixing during flight can be turned ON/OFF by setting a switch. (Always ON at [--] setting)
- A condition delay can be set. A cut switch which can turn OFF the delay function can be set.

\*The display screen is an example. The actual screen depends on the model type.

• Select the function name and return to the Model menu by touching the RTN button. Or the HOME/EXIT button is pushed.



• Condition delay setting

• Condition delay cut switch

**<SensorTouch™>**

- Scrolling
- Moving cursor
- Selecting mode
- Adjusting value

• To next page

• Aileron rate adjustment

| CMB (AIL) NORMAL |       |       |     |
|------------------|-------|-------|-----|
|                  | RATE1 | RATE2 | INH |
| AIL              | +0%   | +0%   |     |
| AIL2             | +0%   | +0%   |     |
| AIL3             | +0%   | +0%   |     |
| AIL4             | +0%   | +0%   |     |

(Glider: Currently selected condition name)

• Flap rate adjustment

| CMB (FLP) NORMAL |       |       |     |
|------------------|-------|-------|-----|
|                  | RATE1 | RATE2 | INH |
| FLAP             | +0%   | +0%   |     |
| FLP2             | +0%   | +0%   |     |

• Elevator rate adjustment

| CMB (ELE) NORMAL |       |       |     |
|------------------|-------|-------|-----|
|                  | RATE1 | RATE2 | INH |
| ELE              | +0%   | +0%   |     |



## Setting method

### ●Activate the function

Move the cursor to the [ACT] item and touch the RTN button to switch to the data input mode. Select the ACT mode by scrolling the touch sensor.

\*The display blinks.

Touch the RTN button to activate the function and return to the cursor mode. (ON is displayed.)

When setting a switch, move the cursor to the [SW] item and touch the RTN button to call the selection screen. Select the switch and set its ON direction. (Always ON at "--" setting)

\*For a description of the switch selection method, see the description at the back of this manual.

### ●Condition delay setting

Move the cursor to the [COND.DELAY] item and touch the RTN button to switch to the data input mode. Adjust the condition delay by scrolling the touch sensor.

Initial value: 0

Adjustment range: 0~27

\*When the RTN button is touched for one second, the rate is reset to the initial value.)

Touch the RTN button to end the adjustment and return to the cursor mode.

When setting a cut switch, move the cursor to the [CUT-SW] item and touch the RTN button to access the selection screen. Select the switch and set its ON direction. (Always ON at "--" setting)

\*For a description of the switch selection method, see the description at the back of this manual.

### ●Rate adjustment

The rates are adjusted by accessing the aileron, flap, and elevator rate screens.

Move the cursor to the rate1 or rate2 item and touch the RTN button to switch to the data input mode. Adjust the rate independently by scrolling the touch sensor.

Initial value: 0%

Adjustment range: -100~+100%

\*When the RTN button is touched for one second, the rate is reset to the initial value.)

Touch the RTN button to end the adjustment and return to the cursor mode.

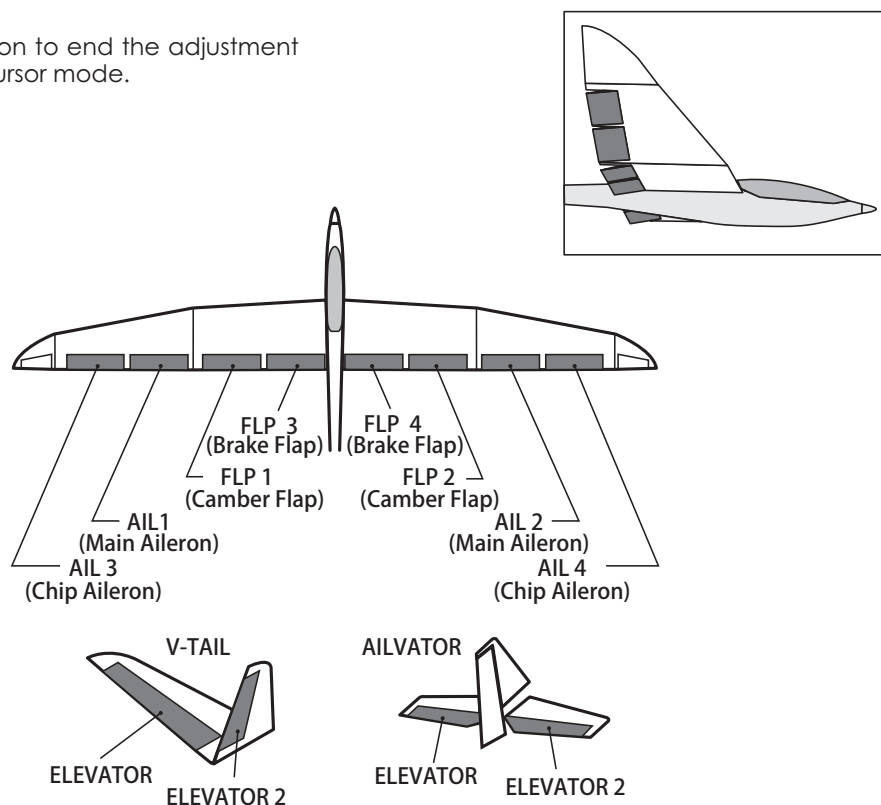

# ELE to CAMBER

[Corresponding model type]: Airplane/glider, 2 ailerons or more

This function is used when you want to mix the camber flaps with elevator operation. When used, the flaps are lowered by up elevator, and lift is increased.

- Select [ELE to CAMBER] at the Model menu and access the setup screen shown below by touching the RTN button.

- Select the function name and return to the Model menu by touching the RTN button. Or the HOME/EXIT button is pushed.

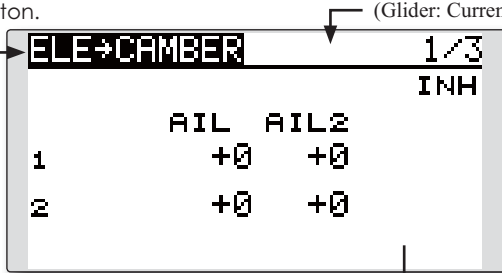

- In-flight mixing can be turned ON/OFF by assigning this to a switch. (Always ON at [--] setting)
- The mixing rate can be adjusted.
- The point that has little effect near the neutral position of the elevator stick can be adjusted. (Glider only)

**Note: The elevator on the tailless wing will also be effected when this mix is activated.**

(Glider: Currently selected condition name)

<SensorTouch™>

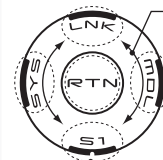

- Scrolling
- Moving cursor
- Selecting mode
- Adjusting value

• To next page

\*The display screen is an example. The actual screen depends on the model type.

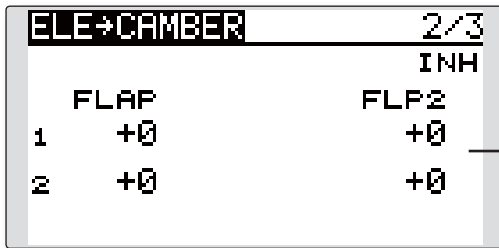

## •Mixing rate adjustment

Move the cursor to the up or down mixing rate item for each servo and touch the RTN button to switch to the data input mode. Adjust the rate independently by scrolling the touch sensor.

Initial value: 0%

Adjustment range: -100~+100%

\*When the RTN button is touched for one second, the rate is reset to the initial value.)

Touch the RTN button to end the adjustment and return to the cursor mode.

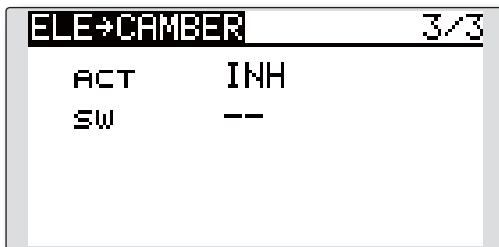

## Setting method

### •Activate the function

Move the cursor to the [ACT] item and touch the RTN button to switch to the data input mode. Select the ACT mode by scrolling the touch sensor.

\*The display blinks.

Touch the RTN button to activate the function and return to the cursor mode. (ON is displayed.)

When setting a switch, move the cursor to the [SW] item and touch the RTN button to call the selection screen. Select the switch and set its ON direction. (Always ON at "--" setting)

\*For a description of the switch selection method, see the description at the back of this manual.

### •Range setting (Glider only)

Move the cursor to the [RANGE] item and hold the elevator stick to the desired position (upper or lower side) and then touch the RTN button for one second to set the range.

\*The mixing does not work near neutral of the elevator stick.

Initial value: 0%

Adjustment range: 0~100%

## CMBFLP to ELE

[Corresponding model type]: Airplane/glider, 2 ailerons + 1 flap or more

When the camber/speed flaps are utilized, the aircraft might experience, a change in pitch. This mix compensates for such changes by incorporating elevator input.

- The elevator servos up/down rates can be adjusted separately. If the mixing direction is reversed, change the mixing rate polarity (+ or -).
- Mixing during flight can be turned ON/OFF by setting a switch. (Always ON at [--] setting)

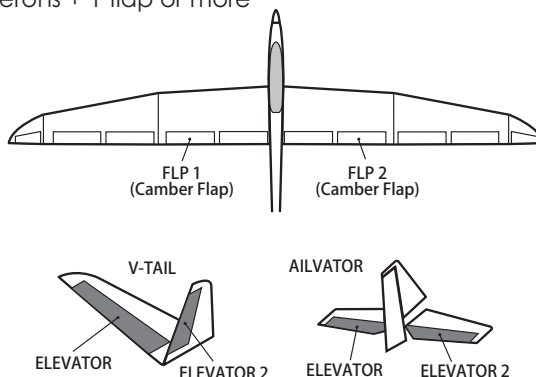

- Select [CMBFLP to ELE] at the Model menu and access the setup screen shown below by touching the RTN button.

• Select the function name and return to the Model menu by touching the RTN button. Or the HOME/EXIT button is pushed.

• Elevator rate adjustment

**CMBFLP→ELE**

|     | RATE1 | RATE2 |
|-----|-------|-------|
| ELE | +0%   | +0%   |
| ACT | INH   |       |
| SW  | --    |       |

(Glider: Currently selected condition name)

<SensorTouch™>

\*The display screen is an example. The actual screen depends on the model type.

### Setting method

#### • Activate the function

Move the cursor to the [ACT] item and touch the RTN button to switch to the data input mode. Select the ACT mode by scrolling the touch sensor.

\*The display blinks.

Touch the RTN button to activate the function and return to the cursor mode. (ON is displayed.)

When setting a switch, move the cursor to the [SW] item and touch the RTN button to call the selection screen. Select the switch and set its ON direction. (Always ON at "--" setting)

\*For a description of the switch selection method, see the description at the back of this manual.

#### • Mixing rate adjustment

Move the cursor to the RATE1 or RATE2 item and touch the RTN button to switch to the data input mode. Adjust the mixing rate independently by scrolling the touch sensor.

Initial value: 0%

Adjustment range: -120~+120%

\*When the RTN button is touched for one second, the rate is reset to the initial value.)

Touch the RTN button to end the adjustment and return to the cursor mode.

# BUTTERFLY

[Corresponding model type]: Glider, Normal: 2 ailerons or more  
Flying: 2 ailerons + 1 flap or more

This function is utilized to quickly slow the aircraft and reduce altitude by simultaneously raising the left and right ailerons and lowering the flaps (camber flap, brake flap).

Butterfly (Crow) produces an extremely efficient landing configuration by accomplishing the following:

1. Slow the aircraft's velocity.
2. Provide washout at the wing tips to reduce the tendency to tip stall.

3. Create more lift toward the center of the wing allowing it to fly at a slower speed

- Mixing during flight can be turned ON/OFF by setting a switch. (Always ON at [--] setting)
- The point at which the butterfly operation reference point can be offset.
- The operational speed of the ailerons and flaps can be adjusted.
- The differential rate can be adjusted.

\*For a description of the setting method, see the aileron differential function.

- Select [BUTTERFLY] at the Model menu and access the setup screen shown below by touching the RTN button.

\*The display screen is an example. The actual screen depends on the model type.

- Select the function name and return to the Model menu by touching the RTN button. Or the HOME/EXIT button is pushed.



- Aileron/flap rate adjustment

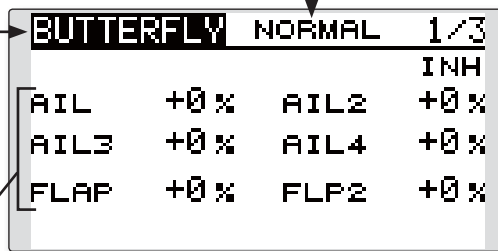

<SensorTouch™>

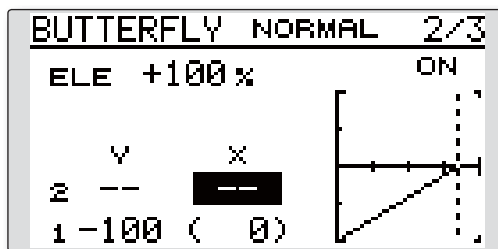
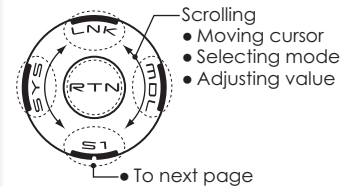

- Elevator adjustment

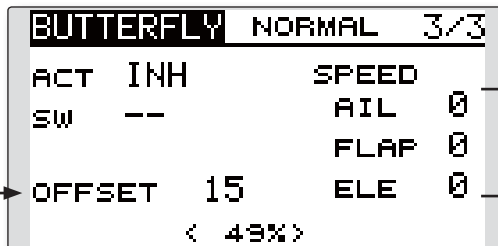

- Servo speed setting

- Butterfly operation reference point

## Setting method

### ● Activate the function

Move the cursor to the [ACT] item and touch the RTN button to switch to the data input mode. Select the ACT mode by scrolling the touch sensor.

\*The display blinks.

Touch the RTN button to activate the function and return to the cursor mode. (ON is displayed.)

When setting a switch, move the cursor to the [SW] item and touch the RTN button to call the selection screen. Select the switch and set its ON direction. (Always ON at "--" setting)

\*For a description of the switch selection method, see the description at the back of this manual.

### ● Rate adjustment

Move the cursor to the aileron, flap or elevator rate item and touch the RTN button to switch to the data input mode. Adjust the rate independently by scrolling the touch sensor.

Initial value: 0%

Adjustment range: -200~+200% (Elevator: -120~+120%)

\*When the RTN button is touched for one second, the rate is reset to the initial value.)

Touch the RTN button to end the adjustment and return to the cursor mode.

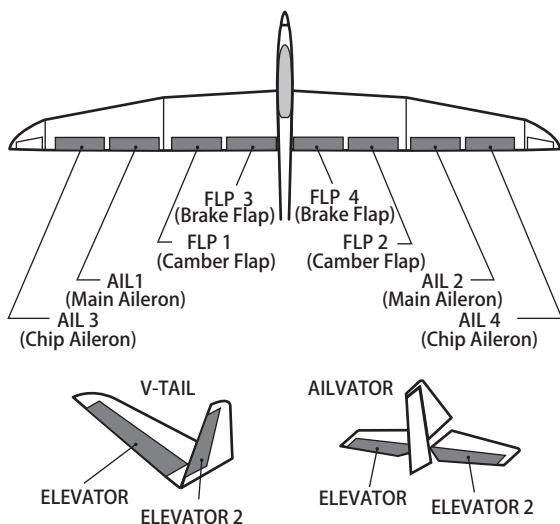

### ● Elevator compensation curve adjustment

|                       | Output (Y) | Position (X)            |
|-----------------------|------------|-------------------------|
| Offset point          | Fixed (0)  | Fixed (offset position) |
| 2- Intermediate point | Settable   | Settable                |
| 1- End point          | Settable   | Fixed                   |

\* The range where mixing does not work close to the neutral position of the elevator stick can be adjusted. (Glider only)

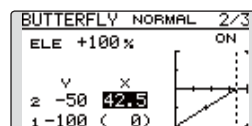
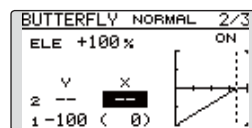

\*When offset is set, the curve is initialized.

### ● Reference point adjustment

Move the cursor to the [OFFSET] item and hold the airbrake stick to the desired position and then touch the RTN button for one second to set the butterfly operational reference point.

Initial value: 0% (upper side)

Adjustment range: 0~100%

### ● Servo speed setting

Move the cursor to the aileron, flap or elevator speed item and touch the RTN button to switch to the data input mode.

Adjust the rate by scrolling the touch sensor.

Initial value: 0

Adjustment range: 0~27 (maximum delay)

\*When the RTN button is touched for one second, the rate is reset to the initial value.)

Touch the RTN button to activate the function and return to the cursor mode.

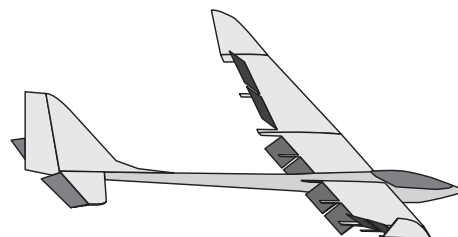

# TRIM MIX

[Corresponding model type]: Glider, 2 ailerons or more

This function adjusts the trim offset rates of the ailerons, elevators, and flaps (camber flaps, brake flaps) according to the flight status.

As an example this function can be set up for launching, with speed flaps and ailerons drooped, and a slight amount of up elevator, and can be used for high speed flying, with both ailerons and speed flaps reflexed slightly, and a bit of down elevator.

To prevent sudden trim changes when switching flight conditions, a delay can be set to provide a

smooth transition between the two conditions. It is also possible to program a cut switch which will turn off the delay.

Furthermore, you can set the auto switch, which will link the trim mix to a stick, switch, or dial.

Additionally, the speed of the aileron, elevator, and flap servos can be adjusted.

- Select [TRIM MIX] at the Model menu and access the setup screen shown below by touching the RTN button.

\*The display screen is an example. The actual screen depends on the model type.

- Select the function name and return to the Model menu by touching the RTN button. Or the HOME/EXIT button is pushed.



(Currently selected condition name)

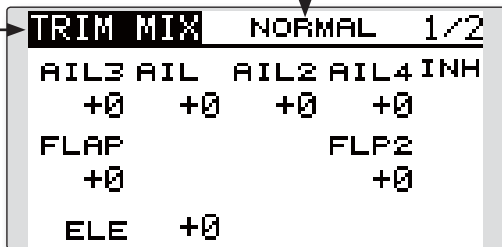

• Ailerons, flaps, and elevators offset rate

<SensorTouch™>

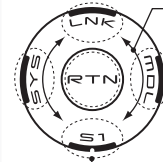

- Scrolling
- Moving cursor
- Selecting mode
- Adjusting value

• To next page

- Switch selection
- Condition delay setting
- Auto switch selection

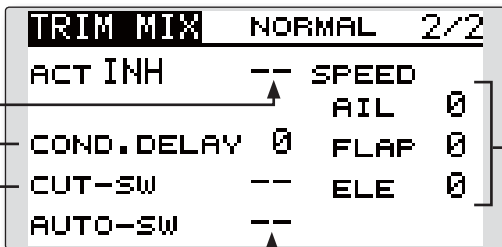

- Ailerons, flaps, and elevators servo speed setting

## Setting method

### ●Activate the function

Move the cursor to the [ACT] item and touch the RTN button to switch to the data input mode. Select the ACT mode by scrolling the touch sensor.

\*The display blinks.

Touch the RTN button to activate the function and return to the cursor mode. (ON is displayed.)

When setting a switch, move the cursor to the switch item and touch the RTN button to access the selection screen. Select the switch and set its ON direction. (Always ON at "--" setting)

\*For a description of the switch selection method, see the description at the back of this manual.

### ●Trim offset rate adjustment

Move the cursor to the aileron, flap or elevator rate item and touch the RTN button to switch to the data input mode. Adjust the rate independently by scrolling the touch sensor.

Initial value: 0%

Adjustment range: -250~+250%

\*When the RTN button is touched for one second, the rate is reset to the initial value.)

Touch the RTN button to end the adjustment and return to the cursor mode.

### ●Condition delay setting

Move the cursor to the [COND.DELAY] item and touch the RTN button to switch to the data input mode. Adjust the condition delay by scrolling the touch sensor.

Initial value: 0

Adjustment range: 0~27

\*When the RTN button is touched for one second, the servo operation position is reset to the initial value.)

Touch the RTN button to end the adjustment and return to the cursor mode.

When setting a cut switch, move the cursor to the [CUT-SW] item and touch the RTN button to access the selection screen. Select the switch and set its ON direction. (Always ON at "--" setting)

\*For a description of the switch selection method, see the description at the back of this manual.

### ●Servo speed setting

Move the cursor to the aileron, flap or elevator speed item and touch the RTN button to switch to the data input mode.

Adjust the rate by scrolling the touch sensor.

Initial value: 0

Adjustment range: 0~27 (maximum delay)

\*When the RTN button is touched for one second, the rate is reset to the initial value.)

Touch the RTN button to activate the function and return to the cursor mode.

### ●Auto switch selection

When selecting an auto switch, move the cursor to the [AUTO-SW] item and touch the RTN button to access the selection screen. Select the switch and set its ON direction. (Always ON at "--" setting)

\*For a description of the switch selection method, see the description at the back of this manual.

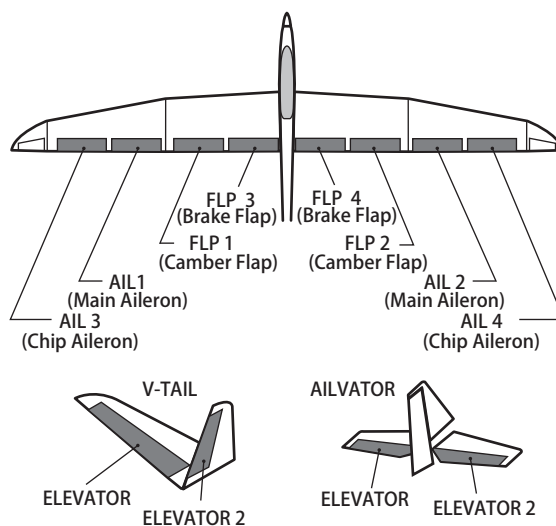

This function is used to increase the aircraft's drag and is useful for landing or diving, etc.

The preset elevators and flaps (camber flap, brake flap) offset amount can be activated by a switch.

The offset amount of the aileron, elevator, and flap servos can be adjusted as needed. Also the speed of the aileron, elevator, and flap servos can be adjusted. If the Auto Mode is activated, this will link the Airbrake to a stick, switch, or dial. A separate stick switch or dial can also be set as the ON/OFF switch.

### Setting example for F3A and other flaperon specifications

(When 2 ailerons model type selected)

Offset rate:

AIL: [-35~-45%], AIL2: [-35~-45%], ELE: [+5~7%]

Note: The input numerics are examples. Adjust the travel to match the aircraft.

Mode setting:

ACT: [ON]

Switch: [SW-C]

AUTO-SW: [-]

- Select [AIRBRAKE] at the Model menu and access the setup screen shown below by touching the RTN button.

\*The display screen is an example. The actual screen depends on the model type.

- Select the function name and return to the Model menu by touching the RTN button. Or the HOME/EXIT button is pushed.



1/2

**AIRBRAKE**

|      |      |      |
|------|------|------|
| AIL  | AIL2 | INH  |
| +0   | +0   |      |
| FLAP |      | FLP2 |
| +0   |      | +0   |
| ELE  | +0   |      |

<SensorTouch™>

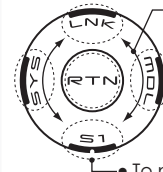

- Scrolling
- Moving cursor
- Selecting mode
- Adjusting value

• To next page

• Ailerons, flaps, and elevators offset rate

2/2

**AIRBRAKE**

|         |    |        |
|---------|----|--------|
| ACT INH | -- | SPEED  |
|         | ↑  | AIL 0  |
|         |    | FLAP 0 |
|         |    | ELE 0  |
| AUTO-SW | -- |        |

- Switch selection
- Ailerons, flaps, and elevators servo speed setting
- Auto switch selection



## Setting method

### ●Activate the function

Move the cursor to the [ACT] item and touch the RTN button to switch to the data input mode. Select the ACT mode by scrolling the touch sensor.

\*The display blinks.

Touch the RTN button to activate the function and return to the cursor mode. (ON is displayed.)

When setting a switch, move the cursor to the switch item and touch the RTN button to access the selection screen. Select the switch and set its ON direction. (Always ON at "--" setting)

\*For a description of the switch selection method, see the description at the back of this manual.

### ●Offset rate adjustment

Move the cursor to the aileron, flap or elevator rate item and touch the RTN button to switch to the data input mode. Adjust the rate independently by scrolling the touch sensor.

Initial value: 0%

Adjustment range: -250~+250%

\*When the RTN button is touched for one second, the rate is reset to the initial value.)

Touch the RTN button to end the adjustment and return to the cursor mode.

### ●Servo speed setting

Move the cursor to the aileron, flap or elevator speed item and touch the RTN button to switch to the data input mode.

Adjust the rate by scrolling the touch sensor.

Initial value: 0

Adjustment range: 0~27 (maximum delay)

\*When the RTN button is touched for one second, the rate is reset to the initial value.)

Touch the RTN button to return to the cursor mode.

### ●Auto switch selection

When setting a auto switch, move the cursor to the [AUTO-SW] item and touch the RTN button to access the selection screen. Select the switch and set its ON direction. (Always ON at "--" setting)

\*For a description of the switch selection method, see the description at the back of this manual.

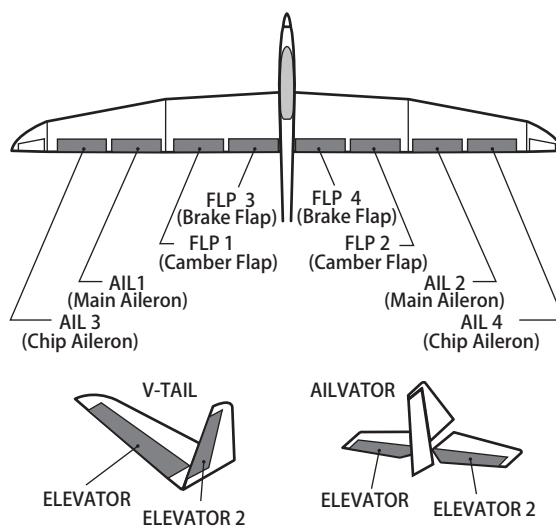

# GYRO

[Corresponding model type]: Airplane/glider, general

This function is used when a GYA Series gyro is used to stabilize the aircraft's attitude. The sensitivity and operation mode (Normal mode/AVCS mode) can be changed via a switch.

- Three rates (Rate 1/Rate 2/Rate 3) can be switched.
- Up to 3 axes (Gyro/Gyro 2/Gyro 3) can be simultaneously controlled.

- Select [GYRO] at the Model menu and access the setup screen shown below by touching the RTN button.

**Note:** This setting does not assign a sensitivity channel. To do so, use the Linkage menu prior to assigning the sensitivity channel (Gyro/Gyro2/Gyro3), be sure to select an unused channel.

Set the [Control] and [Trim] settings other than Function to [--].

[Rate 1 setup screen]

|      |       |      |     |
|------|-------|------|-----|
| GYRO |       |      |     |
| # 1  | GYRO  | AVCS | 0 % |
|      | GYRO2 | AVCS | 0 % |
|      | GYRO3 | AVCS | 0 % |
|      | TYPE  | GY   |     |
|      |       | INH  | --  |

[Rate 2 setup screen]

|      |       |      |     |
|------|-------|------|-----|
| GYRO |       |      |     |
| # 2  | GYRO  | AVCS | 0 % |
|      | GYRO2 | AVCS | 0 % |
|      | GYRO3 | AVCS | 0 % |
|      | TYPE  | GY   |     |
|      |       | INH  | --  |

[Rate 3 setup screen]

|      |       |      |     |
|------|-------|------|-----|
| GYRO |       |      |     |
| # 3  | GYRO  | AVCS | 0 % |
|      | GYRO2 | AVCS | 0 % |
|      | GYRO3 | AVCS | 0 % |
|      | TYPE  | GY   |     |
|      |       | INH  | --  |

**SensorTouch™**

- Scrolling
- Moving cursor
- Selecting mode
- Adjusting value
- To next page

• Select the function name and return to the Model menu by touching the RTN button. Or the HOME/EXIT button is pushed.

• Rate 1-3 setup screen selection

• Gyro type selection

• ACT/INH

• Switch selection

• The operation mode (AVCS/NOR) and sensitivity of the three axis Gyro/Gyro2/Gyro3 can be set.

## Setting method

\*Prior to using the Function menu in the Linkage menu to assign the sensitivity channel (Gyro/Gyro2/Gyro3) select an unused channel.

Set [Control] and [Trim] other than function to [--].

### •Rate1-3 setup screen selection

Move the cursor to the setup screen selection item and touch the RTN button to switch to the data input mode. Select the setup screen # by scrolling the touch sensor.

Touch the RTN button to change the setup screen and return to the cursor mode.

### •Activate the function

Move the cursor to the [INH] item and touch the RTN button to switch to the data input mode. Select the ACT mode by scrolling the touch sensor.

\*The display blinks.

Touch the RTN button to activate the function and return to the cursor mode.

When setting a rate selection switch, move the cursor to the switch item and touch the RTN button to access the selection screen. Select the switch and set its ON direction. (Always ON at "--" setting)

\*For a description of the switch selection method, see the description at the back of this manual.

### ●Gyro type selection

Move the cursor to the gyro type selection item and touch the RTN button to switch to the data input mode. Select the gyro type by scrolling the touch sensor.

[GY]: When a Futaba GYA gyro is used

[NORM]: When using something other than Futaba GYA gyro is used.

Touch the RTN button to change the gyro type and return to the cursor mode.

\*When a Futaba GYA gyro is used and [GY] type is selected, the sensitivity set value is directly read in both the AVCS and NORM modes.

### ●Operation mode selection (GYA gyro)

Move the cursor to the operation mode

selection item and touch the RTN button to switch to the data input mode. Select the operation mode by scrolling the touch sensor.

[AVCS]: AVCS mode

[NORM]: Normal mode

Touch the RTN button to change the operation mode and return to the cursor mode.

### ●Sensitivity setting

Move the cursor to the sensitivity icon and touch the RTN button to switch to the data input mode.

Adjust the sensitivity by scrolling the touch sensor.

Initial value: 0%

Adjustment range: 0~100%

\*When the RTN button is touched for one second, the sensitivity is reset to the initial value.)

Touch the RTN button to return to the cursor mode.

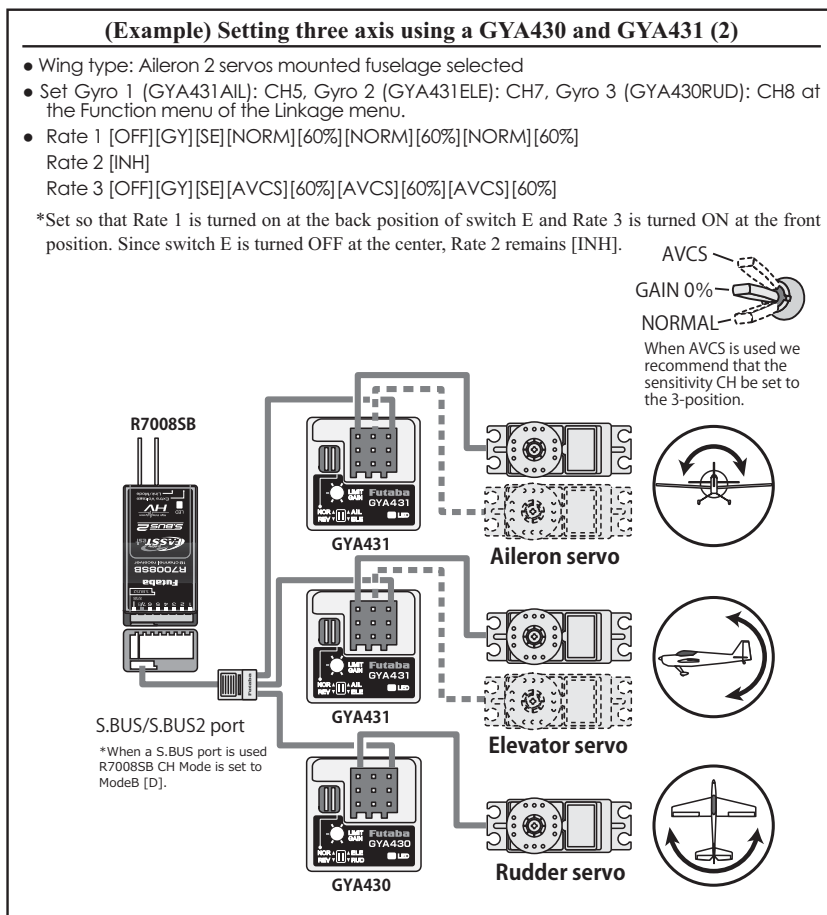

## V-TAIL

[Corresponding model type]: Airplane/glider, V-tail

This function enables adjustments for left and right rudder angle changes during elevator and rudder operation of a V-tail airplane.

V-tail is when two servos are used together to control rudder movement as elevators. In addition to each elevator side moving up and down together, each side moves in opposite directions when moving as rudders. On a V-tail, this is also known as a Ruddervator, as they serve the same purpose.

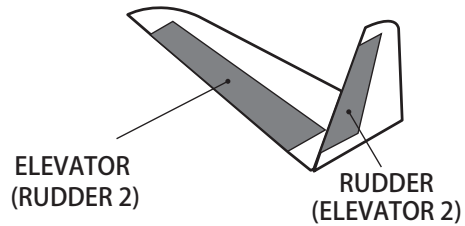

- Select [V-TAIL] at the Model menu and access the setup screen shown below by touching the RTN button.

• Select the function name and return to the Model menu by touching the RTN button. Or the HOME/EXIT button is pushed.

| V-TAIL     |       |       |  |
|------------|-------|-------|--|
| ELEVATOR   |       |       |  |
| ELE <RUD2> | ↑     | ↓     |  |
| RUD <ELE2> | +50 % | +50 % |  |
| RUDDER     |       |       |  |
| ELE <RUD2> | ←     | →     |  |
| RUD <ELE2> | +50 % | +50 % |  |

(Elevator function)  
Up and down travel adjustment of elevator operation

(Rudder function)  
Left and right travel adjustment of rudder operation

### Setting method

#### • Travel adjustment

Move the cursor to the item you want to adjust and touch the RTN button to switch to the data input mode.

Adjust the rate by scrolling the touch sensor.

Initial value: +50%

Adjustment range: -120~+120%

\*When the RTN button is touched for one second, the rate is reset to the initial value.)

Touch the RTN button to return to the cursor mode.

\*If the mixing direction is reversed, adjustments can be made by changing the mixing rate polarity (+ or -).

\*If a large value of travel is specified, when the sticks are moved at the same time, the controls may bind or run out of travel. Decrease the travel until no binding occurs.

# AILEVATOR

[Corresponding model type]: Airplane/glider, Ailevator

(Effective only when 2 servos used at the elevators)

This function improves the performance of the roll axis by operating the elevators as ailerons.

Ailevator is where each elevator in a standard (conventional) or v-tail moves independently, like ailerons on a wing. In addition to each elevator side moving up and down together, each side moves in opposite directions when moving as an Ailevator. On a V-tail, this is also known as a Ruddervator, as they can serve the same purpose. Typically, both Ailevator and ailerons are coupled together to maximize roll performance, especially on larger wingspan planes.

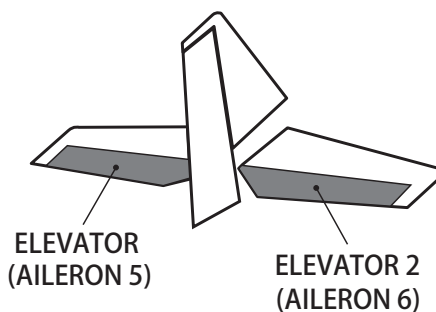

Note: Select Ailevator as the Model Type at the Model Type screen. This changes the output channel. Check the Function menu.

- Select [AILEVATOR] at the Model menu and access the setup screen shown below by touching the RTN button.

• Select the function name and return to the Model menu by touching the RTN button. Or the HOME/EXIT button is pushed.

| AILEVATOR   |       |       |  |
|-------------|-------|-------|--|
| ELEVATOR    | ↑     | ↓     |  |
| ELE <AILS>  | +100% | +100% |  |
| ELE2 <AILS> | +100% | +100% |  |
| AILERON     |       |       |  |
|             | ←     | →     |  |
| ELE <AILS>  | +0%   | +0%   |  |
| ELE2 <AILS> | +0%   | +0%   |  |

(Elevator function)

(Aileron function)

(Elevator function)

- The up and down rate of both elevators when the elevator stick is moved can be individually adjusted.

(Aileron function)

- When the elevators are used as ailerons, aileron travel of the left and right elevators can be adjusted.

## Setting method

### • Travel adjustment

Move the cursor to the item you want to adjust and touch the RTN button to switch to the data input mode.

Adjust the rate by scrolling the touch sensor.

Initial value: ELE: +100%, AIL: 0%

Adjustment range: -120~+120%

\*When the RTN button is touched for one second, the rate is reset to the initial value.)

Touch the RTN button to return to the cursor mode.

\*If the mixing direction is reversed, adjustments can be made by changing the mixing rate polarity (+ or -).

\*If a large value of travel is specified, when the sticks are moved at the same time, the controls may bind or run out of travel. Decrease the travel until no binding occurs.

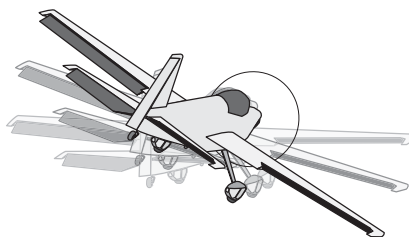

This function adjusts the left and right rudder angles of airplanes with winglets.

Winglets are used to improve the efficiency of aircraft by lowering the lift-induced drag caused by wingtip vortices. The winglet is a vertical or angled extension located at the tip of each wing.

Winglets work by increasing the effective aspect ratio wing without adding greatly to the structural stress and hence necessary weight of its structure - an extension of wing span would also permit lowering of induced drag, though it would cause parasitic drag and would require boosting the strength of the wing and hence its weight. There would come a point at which no overall useful gains would be made. A winglet helps to solve this by effectively increasing the aspect ratio without adding to the span of the wing.

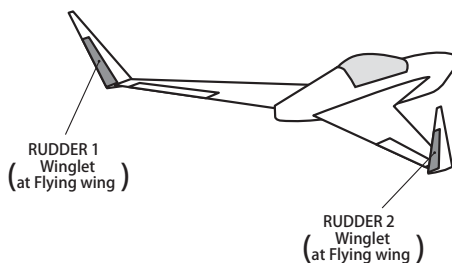

- Select [WINGLET] at the Model menu and access the setup screen shown below by touching the RTN button.

- Select the function name and return to the Model menu by touching the RTN button. Or the HOME/EXIT button is pushed.

**WINGLET**

|         |       |  |       |  |
|---------|-------|--|-------|--|
| RUDDER  | ←     |  | →     |  |
| RUDDER  | +100% |  | +100% |  |
| RUDDER2 | +100% |  | +100% |  |

(Rudder 1/2)

- The travel during rudder stick operation can be individually adjusted.

## Setting method

### • Travel adjustment

Move the cursor to the item you want to adjust and touch the RTN button to switch to the data input mode.

Adjust the rate by scrolling the touch sensor.

Initial value: +100%

Adjustment range: -120~+120%

\*When the RTN button is touched for one second, the rate is reset to the initial value.)

Touch the RTN button to return to the cursor mode.

\*If the mixing direction is reversed, change the mixing rate polarity (+ or -).

This function lets you set the speed when the motor of an F5B or other EP glider is started via a switch. The operation speed can be set for two ranges, slow speed flight and high speed flight (Speed 1/Speed 2). This function can also be operated as a safety function by programming it to a switch.

- The In side and Out side operating speeds can be adjusted independently in 2 ranges (Speed 1/Speed 2).
- The boundary between the 2 ranges can be set. (From Speed 1 to Speed 2)
- The operational speed can only be activated at the initial operation. However, operation can be repeated by setting the switch to OFF before the operation is finished. When you want to reset one

time operation, set the ACT/INH item to [INH] and then reset it to [ON].

- The motor channel is controlled by SW-G. (Glider: Initial setting) When changing the switch or stick which controls the motor, first change Function of the Linkage menu.
- If the Model Type selected is Airplane, the MOTOR function is changed from INH to ON and it is not assigned to another channel, the changes from the throttle channel to the motor channel are enabled.

**Note: Initial setting does not assign a motor channel according to the model type. Prior to assigning the motor channel, find an unused channel. Then, use the Function menu of the Linkage menu.**

**Set [Control] to the switch you want to use and [Trim] to [-].**

**Note: When using this function, always check the initial operation with the propeller removed.**

- Select [MOTOR] at the Model menu and access the setup screen shown below by touching the RTN button.

- Select the function name and return to the Model menu by touching the RTN button. Or the HOME/EXIT button is pushed.



**MOTOR**

ACT            INH            1/2

SW             --             ON

MOTOR OFF    +0             █

OFF

<SensorTouch™>

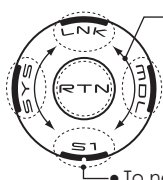

- Scrolling
- Moving cursor
- Selecting mode
- Adjusting value

• To next page

## Setting method

### • Activate the function

When using this function, move the cursor to the [ACT/INH] item and touch the RTN button to switch to the data input mode. Select the [ACT] by scrolling the touch sensor and touch the RTN button.

When selecting the ON/OFF switch, move the cursor to the switch item and touch the RTN button to access the selection screen. Select the switch and set its ON direction. (Always ON at "--" setting)

\*For a description of the switch selection method, see the description at the back of this manual.

### • Motor off position setting

Move the cursor to the [MOTOR OFF] item and touch the RTN button for one second when the motor function switch (SG, etc.) is in the motor OFF position you want to set. The direction of the motor switch is memorized.

The screen graph display OFF direction also changes.

### Note:

- **First decide the motor OFF direction, and then set the speed. When you want to reset the motor OFF direction, also reset the speed.**
- **We recommend that Motor OFF be set in combination with F/S.**
- **Set the basic operation direction with the Reverse function to match the ESC used.**
- **Always set the Motor OFF position.**

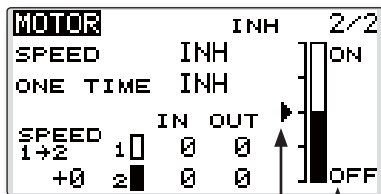

- ON/OFF direction
- Motor function switch current position

### Setting method

#### • Activate the motor speed function

When using motor speed function, move the cursor to the [INH] item and touch the RTN button to switch to the data input mode. Select the [ACT] by scrolling the touch sensor and touch the RTN button.

#### • Sifting the boundary between the 2 ranges

Move the cursor to the [SPEED 1>2] item and touch the RTN button to switch to the data input mode.

Adjust the boundary position by scrolling the touch sensor.

Initial value: 0%

Adjustment range: -100~+100%

\*When the RTN button is touched for one second, the rate is reset to the initial value.)

Touch the RTN button to return to the cursor mode.

#### • Operation speed adjustment

Move the cursor to the [IN] (on to off) or [OUT] (off to on) item and touch the RTN button to switch to the data input mode.

Adjust the operation speed you want to set by scrolling the touch sensor.

Initial value: 0

Adjustment range: 0~27

\*When the RTN button is touched for one second, the rate is reset to the initial value.)

Touch the RTN button to return to the cursor mode.

#### • Set/Reset the one time operation

Move the cursor to the [ONE TIME] item and touch the RTN button to switch to the data input mode.

Select the [ACT] by scrolling the touch sensor and touch the RTN button to set the one time operation.

\*When you want to reset one time operation, set the ACT/INH item to [INH] and then reset it to [ON].

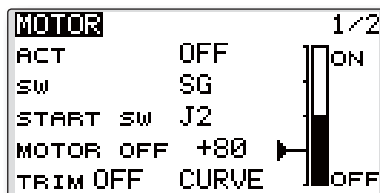

#### • Start switch function

When active, the "START SW" allows the motor's state to change from OFF to ON. The motor is ON when the main SW and "START SW" are turned ON simultaneously. The motor changes to OFF only when the main SW is turned off. If "START SW" is turned OFF but the main SW is still ON, the motor remains ON.

#### [START SW function example]

When the throttle (motor) stick is assigned as the "START SW", and the low throttle position of the throttle curve is adjusted, the motor starts operating with the initial stick movement. The motor will not cease functionality even if the stick position is returned to its lowest setting.

#### • Trim effect / invalid setting in motor OFF

If one of the trim levers is assigned to the Motor function, it is possible to turn the motor off with the trim lever. To maintain compatibility after updating the T14SG/S, the trim setting is adjusted to the on position. However, it is suggested to return it to the off position accordingly in the programming of the transmitter.

\*Data Reset will return the trim setting to the off position.

#### • Screen at the time of the motor OFF setting

When the MOTOR OFF setting is highlighted, you will note the presence of the small cursor that indicates the MOTOR OFF position. To adjust this MOTOR OFF position, use the throttle stick to move the cursor accordingly. When satisfied with this position, press and hold the RTN button on the transmitter.

\*The larger cursor is used to indicate the output of the motor channel. This cursor reflects any throttle curves and motor mixing which may be active.

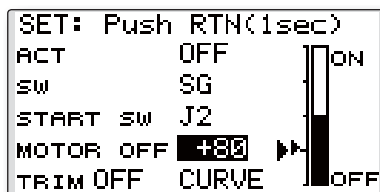

#### • Throttle curve button

When "CURVE" button is chosen, a throttle curve screen opens.

\*When a throttle function is assigned to either channel, the "CURVE" button is not displayed because a throttle curve does not function as a motor curve.



This function is used when you want to mix elevator operation with rudder operation. It is used to correct undesirable tendencies when rudder is applied in rolling maneuvers such as, knife edge flight.

- Mixing during flight can be turned ON/OFF by setting a switch. (Always ON at [-] setting)
- Link mixing can be set: Links this mix to other mixes.

- Select [RUD to ELE] at the Model menu and access the setup screen shown below by touching the RTN button.

• Select the function name and return to the Model menu by touching the RTN button. Or the HOME/EXIT button is pushed.

• Select the function name and return to the Model menu by touching the RTN button. Or the HOME/EXIT button is pushed.

<SensorTouch™>

- Scrolling
- Moving cursor
- Selecting mode
- Adjusting value
- To next page

## Setting method

### • Activate the function

Move the cursor to the [ACT] item and touch the RTN button to switch to the data input mode. Select the ACT mode by scrolling the touch sensor.

\*The display blinks.

Touch the RTN button to activate the function and return to the cursor mode. (ON is displayed.)

When selecting a switch, move the cursor to the [SW] item and touch the RTN button to call the selection screen. Select the switch and set its ON direction. (Always ON at "--" setting)

\*For a description of the switch selection method, see the description at the back of this manual.

### • 5-point curve setting (airplane)

[Curve rate setting]

1. Move the cursor to the curve rate setting item (left side) you want to adjust and touch the RTN button to switch to the data input mode.

Adjust the rate by scrolling the touch sensor.

Adjustment range: -100%~+100%

\*When the RTN button is touched for one second, the rate is reset to the initial value.)

Touch the RTN button to end the adjustment and return to the cursor mode.

2. Repeat this procedure for each point.

[Moving curve point]

1. Move the cursor to the curve point setting item you want to adjust and touch the RTN button to switch to the data input mode.

Adjust the curve point by scrolling the touch sensor.

Adjustment range: Up to 2.5% in front of the adjoining point

\*When the RTN button is touched for one second, the curve position is reset to the initial value.)

Touch the RTN button to end the adjustment and return to the cursor mode.

2. Repeat this procedure for each point.

[Deleting/returning curve point]

Move the cursor to the curve point setting item you want to delete/return and touch the RTN button for one second.

### • Link mode setting

When selecting the link mixing, move the cursor to the [LINK] item and touch the RTN button to switch to the data input mode. Select the ON mode by scrolling the touch sensor.

\*The display blinks.

Touch the RTN button to set the link mode and return to the cursor mode.

# SNAP ROLL

[Corresponding model type]: Airplane, general

This function selects the switch and rate adjustment of ailerons, elevators, and rudder when a snap roll is performed.

- Four snap roll directions can be set. (Right/up, right/down, left/up, left/down)
- Operation mode: When [Master] mode is selected, the Snap Roll function is turned ON/OFF by the master switch. It is possible to set the direction switch was switched to the direction in which you want to snap roll. When [Single] mode is selected, the snap roll in each direction can be executed by means of independent switches and positions.
- A safety switch can be set to prevent the inadvertent activation of the snap roll. For example, the landing gear is lowered, even if the switch is turned on accidentally the snap roll would not be executed. The snap roll switch is activated only when the safety switch is OFF.

## (Example) Setting example for F3A

- Mode: [Master]
- Safety SW: [SG] (Safety measure)
- Master SW: [SH] (Main switch for executing snap roll)
- Direction switches:
  - \*The snap roll up side left and right and down side left and right direction switches are selected here.
  - Right/Up: OFF [SD]
  - Right/Down: OFF [SD]
  - Left/Up: OFF [SA]
  - Left/Down: OFF [SA]

- Select [SNAP ROLL] at the Model menu and access the setup screen shown below by touching the RTN button.

• Select the function name and return to the Model menu by touching the RTN button. Or the HOME/EXIT button is pushed.

<SensorTouch™>

- Scrolling
- Moving cursor
- Selecting mode
- Adjusting value

• To next page

|     | AIL  | ELE  | RUD  |
|-----|------|------|------|
| ↗/↑ | +100 | +100 | +100 |
| ↘/↓ | +100 | -100 | -100 |
| ↖/↑ | -100 | +100 | -100 |
| ↙/↓ | -100 | -100 | +100 |

| SNAP ROLL |        | 2/3 |
|-----------|--------|-----|
| MODE      | MASTER | ←   |
| MASTER-SW | --     |     |
| SAFETY-SW | --     |     |

- Master/single mode selection

|     | ACT | SW |
|-----|-----|----|
| ↗/↑ | OFF | -- |
| ↘/↓ | OFF | -- |
| ↖/↑ | OFF | -- |
| ↙/↓ | OFF | -- |

- Direction switches

---

## Setting method

---

### ●Master/single mode selection

Move the cursor to the [MODE] item and touch the RTN button to switch to the data input mode. Select the master or single mode by scrolling the touch sensor.

\*The display blinks.

[MASTER]: Master mode

[SINGLE]: Single mode

Touch the RTN button to select the mode and return to the cursor mode.

When setting a master switch, move the cursor to the [MASTER-SW] item and touch the RTN button to access the selection screen. Select the switch and set its ON direction.

\*For a description of the switch selection method, see the description at the back of this manual.

When setting a safety switch, move the cursor to the [SAFETY-SW] item and touch the RTN button to access the selection screen. Select the switch and set its ON direction.

### ●Direction switch selection

Move the cursor to the direction switch item and touch the RTN button to access the selection screen. Select the switch and set its ON direction.

\*For a description of the switch selection method, see the description at the back of this manual.

### ●Rate adjustment

Move the cursor to the aileron, elevator or rudder item for each direction and touch the RTN button to switch to the data input mode. Adjust the rate independently by scrolling the touch sensor.

Initial value: (Dependent upon the snap roll direction)

Adjustment range: -150~+150%

\*When the RTN button is touched for one second, the rate is reset to the initial value.)

Touch the RTN button to end the adjustment and return to the cursor mode.

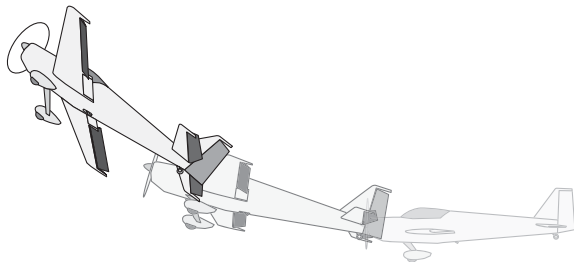

## MODEL MENU (HELICOPTER)

This section contains information on the commands that apply to helicopters only. For instructions on Airplanes and Sailplanes, refer to the sections pertaining to those aircraft.

Use the Model Type function in the Linkage Menu to select the swash type matched to the respective aircraft.

Also, activate/deactivate flight conditions according to your model. To do so, access at the

Condition Select screen prior to adjusting the model's parameters. (Up to five conditions can be used)

The Dual Rate function and other functions common to all model types have already been described elsewhere in this manual. Please refer to these respective sections for information on how to do so.

- Access the Model menu shown below by touching the RTN button twice at the home screen, etc.

• Select the function name and return to the Model menu by touching the RTN button. Or the HOME/EXIT button is pushed.

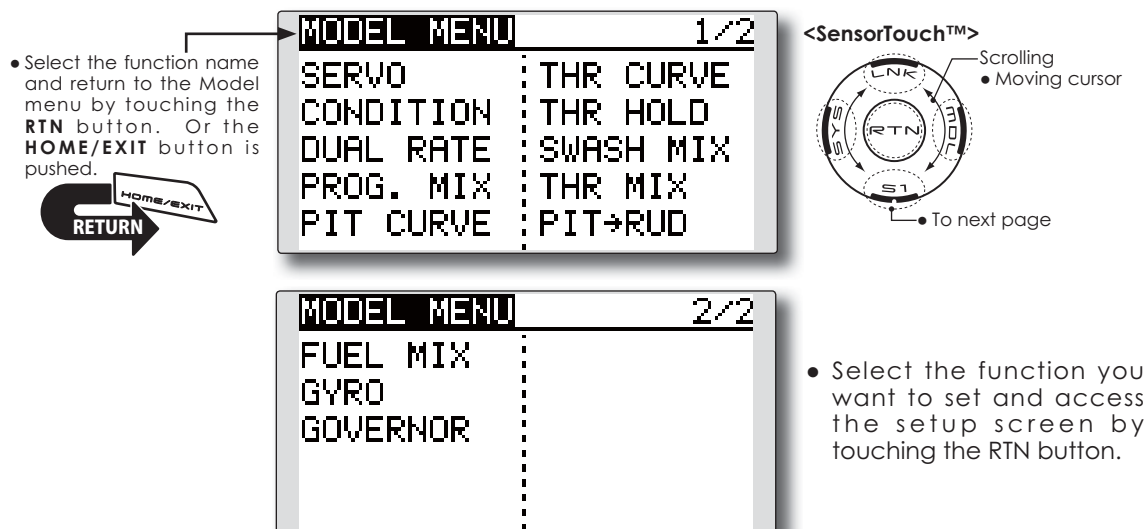

<SensorTouch™>

Scrolling  
• Moving cursor

• To next page

- Select the function you want to set and access the setup screen by touching the RTN button.

### Model Menu functions (helicopter) list

**PIT CURVE:** Adjusts pitch settings in different flight conditions

**THR CURVE:** Throttle curve and hovering trim adjustment in different flight conditions

**THR HOLD:** Moves the throttle to idle during autorotation

**SWASH MIX:** Compensates control response in different flight conditions

**THROTTLE MIX:** Compensates for power loss when cyclic applied

**PIT to NEEDLE:** Adjusts pitch response in different flight conditions

**PIT to RUD:** Compensates torque changes from pitch angle inputs

**GYRO:** Used to switch gyro sensitivity

**GOVERNOR:** Used to switch RPM of the helicopter's head

# PIT CURVE/PIT TRIM

## Pitch Curve

This function adjusts the pitch operation curve for each flight condition to optimize the model's performance in relationship to the throttle stick position.

\*A simple curve can be created by reducing the number of input points to two or three, and then entering the specified value at the corresponding points.

- Select [PIT CURVE] at the Model menu and access the setup screen shown below by touching the RTN button.

- Select the function name and return to the Model menu by touching the RTN button. Or the HOME/EXIT button is pushed.

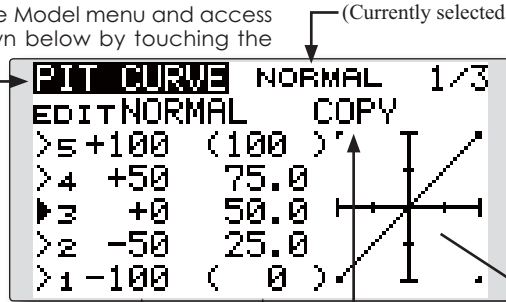

<SensorTouch™>

- Scrolling
- Moving cursor
- Selecting mode
- Adjusting value

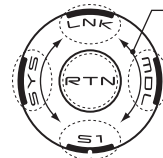

• To next page

\*The graph display includes the pitch trim operation.

- curve rate
- curve point
- Pitch curve copy

## Setting method

### •5-point curve setting

[Curve rate setting]

1. Move the cursor to the curve rate setting item you want to adjust and touch the RTN button to switch to the data input mode.  
Adjust the rate by scrolling the touch sensor.  
Initial value: P1: -100%, P2: -50%, P3: 0%, P4: +50%, P5: +100%  
Adjustment range: -100%~+100%

\*When the RTN button is touched for one second, the rate is reset to the initial value.

Touch the RTN button to end the adjustment and return to the cursor mode.

2. Repeat this procedure for each point as desired.

[Moving curve point]

1. Move the cursor to the curve point setting item you want to adjust and touch the RTN button to switch to the data input mode.  
Adjust the curve point by scrolling the touch sensor.  
Initial value: P1: (0%), P2: 25%, P3: 50%, P4: 75%, P5: (100%)  
Adjustment range: Up to 2.5% in front of the adjoining point

\*When the RTN button is touched for one second, the curve position is reset to the initial value.)

Touch the RTN button to end the adjustment and return to the cursor mode.

2. Repeat this procedure for each point as desired.

[Deleting/returning curve point]

1. Move the cursor to the curve point setting item you want to delete/return and touch the RTN button for one second.

### •Pitch curve copy function

Move the cursor to COPY and touch the RTN button to switch to the data input mode. Select the copy destination condition by scrolling the touch sensor and touch the RTN button. Select the [YES] and touch the RTN button.

### Normal curve adjustment

\*For normal curve, create a basic pitch curve centered about hovering. Use this function together with the THR Curve (Normal) function and adjust the curve so that up/down control is best at a constant engine speed.

### Idle up curve adjustment

\*For the high side pitch curve, set the maximum pitch so that it does not overload the engine. For the low side pitch curve, create curves matched to loop, roll, 3D, and other purposes and use the idle up curves according to the performance.

### Throttle hold curve adjustment

\*The throttle hold curve is used when executing auto rotations.

## Operation precautions

### ⚠ Warning

- ! When actually starting the engine and flying, always set the idle up condition switch to OFF and start the engine at idle.

---

## Curve setting examples

---

The screens shown below are curves created by entering the pitch rate at low, center, and high side (3 points or 5 points) at each condition.

When actually creating a curve, input the rate specified by the model (or the reference value).

### ●Pitch Curve (Example)

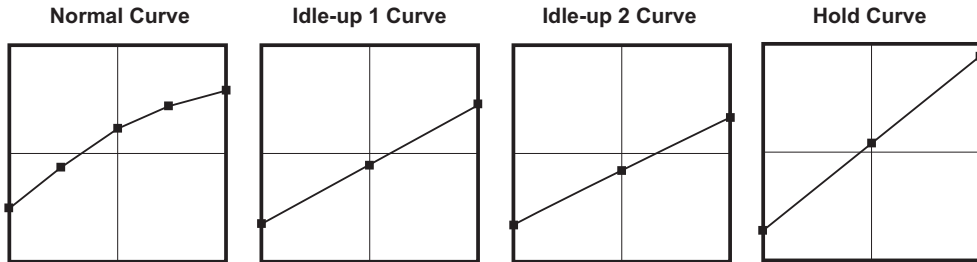

---

## Pitch Trim (Hovering pitch, high pitch, low pitch)

[Hovering pitch trim setting]

```
PIT CURVE NORMAL 2/3
HOVER EDIT NORMAL
ACT ON LD
MODE CTRM
RATE +30% (< +0%)
RANGE 100%
```

### Hovering pitch trim

The Hovering Pitch trim function trims the pitch near the hovering point. Normally, it is used with the hovering condition. The hovering pitch can be fine tuned for changes in rotor speed accompanying changes in temperature, humidity, and other flight conditions. Adjust the hovering pitch so that rotor speed is constant. This function can be used together with the Hovering Throttle Trim function for more precise operation.

### Setting method

- Set the function to ACT [ON]. (initial setting)
- Select the adjustment knob.  
Selection example: LD (initial setting)
- The trim operation mode (Mode: CTRM/NORM) can be selected.  
**CTRM mode:** Maximum amount of change near center by center trim operation (recommended)  
**NORM mode:** Normal trim (parallel movement trim) operation. The advantage of using this mode is that the hovering pitch can be adjusted without changing the curve.
- The trim rate can be adjusted and the operation direction can be changed.
- Trim adjustment range (Range) setting  
When this value is made small, trim can only be used near the center.

---

[Low/High pitch trim setting]

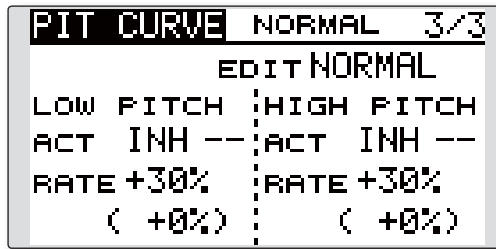

---

### High Pitch/Low Pitch Trim

High Pitch/Low Pitch Trim is the pitch servo high side and low side trim function.

---

### Setting method

- Set the function to ACT (ON).
- Select the adjustment knobs.  
Selection example: LS (high side), RS (low side)
- The trim rate can be adjusted and the operation direction can be changed.
- Trim acts as high side or low side trim with the center as the standard.

# THR CURVE/THROTTLE HOVER TRIM

## Throttle Curve

Throttle curve function adjusts the throttle operation curve for each condition to optimize the engine speed to throttle stick movement.

The Throttle Hover function trims the throttle near the hovering point. Normally, use it with hovering conditions. Changes in rotor speed

accompanying changes in the temperature, humidity, and other flight conditions can be trimmed. Adjust the throttle so that rotor rotation is most stable. More precise trimming is also possible by using this function along with the Hover Pitch function.

- Select [THR CURVE] at the Model menu and access the setup screen shown below by touching the RTN button.
- Select the function name and return to the Model menu by touching the RTN button. Or the HOME/EXIT button is pushed.

The screenshot shows the following data table:

| Curve No. | Curve Rate (%) | Curve Point (%) |
|-----------|----------------|-----------------|
| 5         | 100.0          | 100             |
| 4         | 75.0           | 75.0            |
| 3         | 50.0           | 50.0            |
| 2         | 25.0           | 25.0            |
| 1         | 0.0            | 0               |

The graph displays a linear throttle curve. The touch sensor diagram shows buttons: LNK, RTN, S1, and S2. Functions include Scrolling, Moving cursor, Selecting mode, Adjusting value, and To next page.

- curve rate
- curve point
- Throttle curve copy

(Currently selected condition name)

\*The graph display includes the throttle hover trim operation.

## Setting method

### •5-point curve setting

[Curve rate setting]

1. Move the cursor to the curve rate setting item you want to adjust and touch the RTN button to switch to the data input mode. Adjust the rate by scrolling the touch sensor. Initial value: P1: 0%, P2: 25%, P3: 50%, P4: 75%, P5: 100%  
Adjustment range: 0%~100%  
\*When the RTN button is touched for one second, the rate is reset to the initial value.)

Touch the RTN button to end the adjustment and return to the cursor mode.

2. Repeat this procedure for each point as desired.

[Moving curve point]

1. Move the cursor to the curve point setting item you want to adjust and touch the RTN button to switch to the data input mode. Adjust the curve point by scrolling the touch sensor. Initial value: P1: (0%), P2: 25%, P3: 50%, P4: 75%, P5: (100%)  
Adjustment range: Up to 2.5% in front of the adjoining point

\*When the RTN button is touched for one second, the curve position is reset to the initial value.)

Touch the RTN button to end the adjustment and return to the cursor mode.

2. Repeat this procedure for each point as desired.

[Deleting/returning curve point]

1. Move the cursor to the curve point setting item you want to delete/return and touch the RTN button for one second.

### •Throttle curve copy function

Move the COPY item and touch the RTN button to switch to the data input mode. Select the copy destination condition by scrolling the touch sensor and touch the RTN button. Select the [YES] and touch the RTN button.

### Normal curve adjustment

\*Normal curve creates a basic curve centered around hovering. Use it along with the normal pitch curve and adjust so that up/down control results in a constant engine speed.

### Idle up curve adjustment

\*Set a idle up curve that maintains a constant speed at all times, even during operation which reduces the pitch performed in flight. Create a curve matched to loop, roll, 3D, or other purposes and the idle up curve according to the performance.

## Operation precautions

### ⚠ Warning

- When actually starting the engine and flying, always set the idle up condition switch to OFF and start the engine at the idle.



---

## Curve setting examples

---

The curves shown below are created by inputting the data of the 5 points 0% (low side), 25%, 50% (center), 75%, 100% (high) side for each

condition. When actually creating a curve, enter the parameters specified per the model (or the reference value).

### •Throttle Curve (Example)

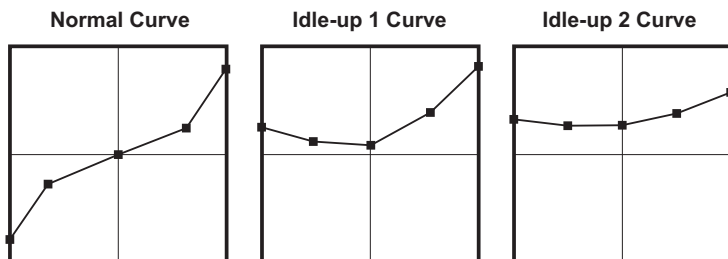

---

## Throttle Hover trim

[Throttle hover trim setting]

|           |        |        |
|-----------|--------|--------|
| THR CURVE | NORMAL | 2/3    |
| HOVER     | EDIT   | NORMAL |
| ACT       | ON     | RD     |
| MODE      | CTRM   |        |
| RATE      | +30%   | ( -1%) |
| RANGE     | 100%   |        |

### Setting method

---

- Set the function to ACT ([ON]). (initial setting)
- Select the adjustment knob.  
Selection example: RD (initial setting)
- The trim operation mode (Mode: CTRM/ NORM) can be selected.  
**CTRM mode:** Maximum rate of change near center by center trim operation (recommended)  
**NORM mode:** Normal trim (horizontal movement trim) operation.
- The trim rate can be adjusted and the operation direction can be set.
- Trim adjustment range (Range) setting  
With smaller values, the trim is only active near the center.

## Throttle limiter function

This function limits the high range of the throttle movement by any slider or trimmer.

\*Control which adjusts the limit point during flight can be set.

[Throttle limiter setting]

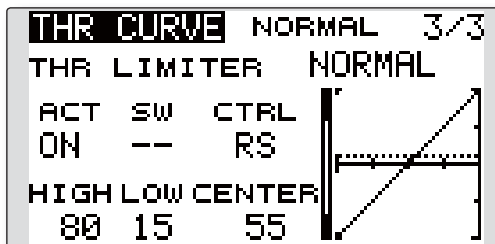

### Setting method

\*Set at the 3rd page of the throttle curve screen.

#### •Activate the function.

1. Select ACT and touch the RTN button.
2. Switch the display to ACT by scrolling the touch sensor.

\*The display blinks.

INH: Inhibit

ACT: Activate

3. Enter the selection by touching the RTN button.

#### •ON/OFF switch setting

1. Select SW and touch the RTN button.
2. The H/W SET screen is displayed. Select the hardware and touch the RTN button.

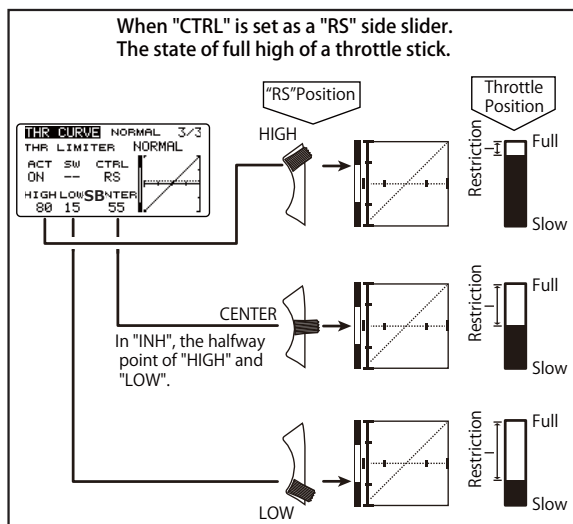

#### •High side operating range setting

1. Select HIGH and touch the RTN button.
2. Adjust the high side operating range by scrolling the touch sensor.

\*A gauge is displayed at the left side of the graph.

3. Touch the RTN button to switch to the cursor mode.

#### •Low side operating range setting

1. Select LOW and touch the RTN button.
2. Adjust the low side operating range by scrolling the touch sensor.

\*A gauge is displayed at the left side of the graph.

3. Touch the RTN button to switch to the cursor mode.

#### •Limiter operating range adjustment control setting

1. Select CTRL and touch the RTN button.
2. The H/W SET screen is displayed. Select the hardware and touch the RTN button.

\*The throttle limiter operating position is indicated by a dotted line on the graph.

\*When limiter operating range adjustment control is NULL, the throttle limiter function is not performed.

#### •Changing the control center position

1. Select CENTER and touch the RTN button for 1 second. CENTER changes from INH to "rate display".
2. When the CENTER rate is changed, the neutral position of the hardware set at CTRL can be adjusted.

\*When CENTER is INH, the neutral position becomes the LOW intermediate value.

\*When CENTER is changed from INH to "rate display", the CENTER rate is set to the LOW intermediate value.

\*The CENTER rate can be set between HIGH and LOW.

## THR HOLD

This function sets the throttle cut position for auto rotation. The throttle servo operating speed can be adjusted. (Speed)

**Note:** Initially, this setting does not assign the throttle hold switch. Prior to adjusting the parameters for the throttle hold, we suggest designating a throttle hold switch. To do so, access the Condition menu within the Model menu options.

- Select [THR HOLD] at the Model menu and access the setup screen shown below by touching the RTN button.

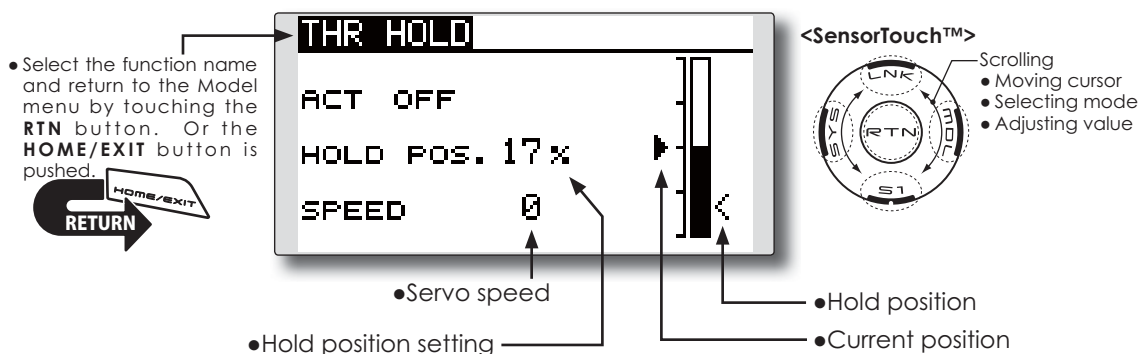

### Setting method

#### • Hold condition switch selection

Use the Condition select menu of the Model menu to assign the hold condition switch. Selection example: SG

#### • Hold position adjustment

Move the cursor to the hold position item and touch the RTN button to switch to the data input mode.

Adjust the rate by scrolling the touch sensor.  
Initial value: 17%

Adjustment range: 0%~50%

\*Hold position sets the throttle cut position. Adjust it so that the carburetor is completely closed.

\*When the RTN button is touched for one second, the rate is reset to the initial value.)

Touch the RTN button to end the adjustment and return to the cursor mode.

#### • Servo speed setting

Move the cursor to the servo speed item and touch the RTN button to switch to the data input mode.

Adjust the rate by scrolling the touch sensor.  
Initial value: 0

Adjustment range: 0~27 (maximum delay)

\*When the RTN button is touched for one second, the rate is reset to the initial value.)

Touch the RTN button to return to the cursor mode.

### Operation precautions

#### ⚠ Warning

! When actually starting the engine and flying, always set the idle up condition switch to OFF and start the engine at idle.

# SWASH MIX

The swash mix function is used to correct the swash plate in the aileron (roll) direction and elevator (cyclic pitch) corresponding to each operation of each condition.

This function allows the independent rate adjustments for the ailerons, elevator and pitch.

- Select [SWASH MIX] at the Model menu and access the setup screen shown below by touching the RTN button.

- Select the function name and return to the Model menu by touching the RTN button. Or the HOME/EXIT button is pushed.



(Currently selected condition name)

|                  |               |              |
|------------------|---------------|--------------|
| <b>SWASH MIX</b> | <b>NORMAL</b> | <b>1/2</b>   |
| <b>EDIT</b>      |               |              |
| <b>NORMAL</b>    | <b>RATE1</b>  | <b>RATE2</b> |
| AIL→ELE          | +0 %          | +0 %         |
| ELE→AIL          | +0 %          | +0 %         |
| PIT→AIL          | +0 %          | +0 %         |
| PIT→ELE          | +0 %          | +0 %         |

•Condition selection

<SensorTouch™>

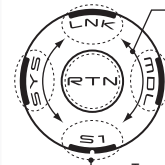

- Scrolling
- Moving cursor
- Selecting mode
- Adjusting value

• To next page

|                  |                    |
|------------------|--------------------|
| <b>SWASH MIX</b> | <b>2/2</b>         |
|                  | <b>ACT SW TRIM</b> |
| AIL→ELE          | INH -- OFF         |
| ELE→AIL          | INH -- OFF         |
| PIT→AIL          | INH --             |
| PIT→ELE          | INH --             |

## Setting method

### •Activate the mixing

When using this function, move the cursor to the [ACT] item and touch the RTN button to switch to the data input mode.

Select the ACT mode by scrolling the touch sensor.

\*The display blinks.

Touch the RTN button to activate the mixing and return to the cursor mode. (ON is displayed.)

[Switch selection]

When [ -- ] is set, the swash mixing function is always active and operated by merely selecting the condition.

When setting an [ON]/[OFF] switch, move the cursor to the [SW] item and touch the RTN button to access the selection screen. Set the switch and its ON position.

\*For a description of the switch selection method, see the description at the back of this manual.

### •Mixing rate adjustment

Move the cursor to the mixing rate item you want to correct and touch the RTN button to switch to the data input mode. Adjust the rate independently by scrolling the touch sensor.

Initial value: 0%

Adjustment range: -100~+100%

\*When the RTN button is touched for one second, the rate is reset to the initial value.

Touch the RTN button to end the adjustment and return to the cursor mode.

### •Trim mode ON/OFF setting

When changing the trim mode, move the cursor to the [TRIM] item and touch the RTN button to switch to the data input mode.

Select ON/OFF by scrolling the touch sensor.

\*The display blinks.

Touch the RTN button to change the trim mode ON/OFF and return to the cursor mode.

\*When mixing includes master side trim, select [ON] and when mixing does not include master trim, select [OFF].

### Example of use

- As an example, use swash mixing to correct undesirable roll tendencies.
- For a condition which uses AIL to ELE, set this function to ON.

If the front of the helicopter raises during a right roll, when the Rate 2 side is input and the right aileron is operated, the elevator moves to the down side. Tune by adjusting the Rate.

For left roll, adjust to the Rate 1 side.

# THROTTLE MIX

This function corrects slowing of engine speed caused by swash plate operation during aileron or elevator operation. The method of applying clockwise or counterclockwise torque when pirouetting can also be corrected.

**Setting example**

- ALL to THR mixing counteracts the lag in engine RPM's when an aileron input is given to the helicopter. Engine over-speeding can be adjusted independently for the right aileron and left aileron inputs utilizing Rates 1 and 2.

- Select [THROTTLE MIX] at the Model menu and access the setup screen shown below by touching the RTN button.

- Select the function name and return to the Model menu by touching the RTN button. Or the HOME/EXIT button is pushed.



(Currently selected condition name)

|         |        |       |
|---------|--------|-------|
| THR MIX | NORMAL | 1/2   |
| EDIT    |        |       |
| NORMAL  | RATE1  | RATE2 |
| AIL→THR | +0%    | +0%   |
| ELE→THR | +0%    | +0%   |
| RUD→THR | +0%    | +0%   |

- Condition selection

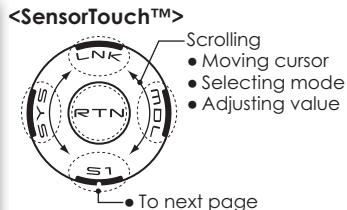

|         |     |     |      |
|---------|-----|-----|------|
| THR MIX |     | 2/2 |      |
|         | ACT | SW  | MODE |
| AIL→THR | INH | --  | CTRM |
| ELE→THR | INH | --  | CTRM |
| RUD→THR | INH | --  | CTRM |

## Setting method

### •Activate the mixing

When using this function, move the cursor to the [ACT] item and touch the RTN button to switch to the data input mode.

Select the ACT mode by scrolling the touch sensor.

\*The display blinks.

Touch the RTN button to activate the mixing and return to the cursor mode. (ON is displayed.)

[Switch selection]

When [ -- ] is set, the swash mixing function is always active and operated by merely selecting the condition.

When setting an [ON]/[OFF] switch, move the cursor to the [SW] item and touch the RTN button to call the selection screen. Set the switch and its ON position.

\*For a description of the switch selection method, see the description at the back of this manual.

### •Mixing rate adjustment

Move the cursor to the mixing rate item you want to correct and touch the RTN button to switch to the data input mode. Adjust the

rate independently by scrolling the touch sensor.

Initial value: 0%

Adjustment range: -100~+100%

\*When the RTN button is touched for one second, the rate is reset to the initial value.)

Touch the RTN button to end the adjustment and return to the cursor mode.

### •Operation mode setting

Move the cursor to the [MODE] item and touch the RTN button to switch to the data input mode.

Select the operation mode by scrolling the touch sensor.

\*The display blinks.

CTRM mode: Corrects near the center only.

LIN. mode: Corrects the complete range.

Touch the RTN button to change the operation mode and return to the cursor mode.

# PIT to RUD mixing (Revolution mixing)

Use this mix when you want to suppress the reaction torque generated by main rotor pitch and speed changes during pitch operation. Adjust so that the nose does not move in the rudder direction.

**Note:** When a GY Series or other heading hold gyro is used, since correction is performed by the gyro, this mix is not utilized. If this function is used when the gyro operation mode is the AVCS mode, the neutral position will change.

- Select [PIT to RUD] at the Model menu and access the setup screen shown below by touching the RTN button. (Currently selected condition name)

- Select the function name and return to the Model menu by touching the RTN button. Or the HOME/EXIT button is pushed.

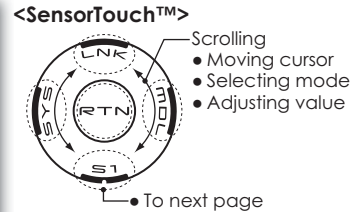
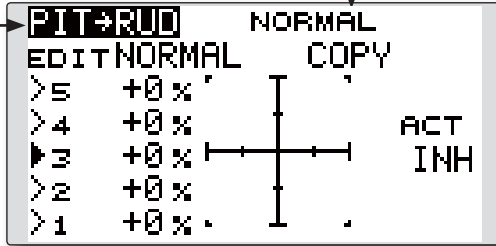

## Setting method

### •Activate the mixing

When using this function, move the cursor to the [ACT] item and touch the RTN button to switch to the data input mode.

Select the ACT mode by scrolling the touch sensor.

\*The display blinks.

Touch the RTN button to activate the mixing and return to the cursor mode. (ON is displayed.)

### •5-point curve setting

Move the cursor to the curve rate setting item you want to adjust and touch the RTN button to switch to the data input mode.

Adjust the rate by scrolling the touch sensor.

Initial value: P1~P5: 0%

Adjustment range: -100%~+100%

\*When the RTN button is touched for one second, the rate is reset to the initial value.)

Touch the RTN button to end the adjustment and return to the cursor mode.

Repeat this procedure for each point.

### •Pitch curve copy function

Move the cursor to COPY item and touch the RTN button to switch to the data input mode. Select the copy destination condition by scrolling the touch sensor and touch the RTN button. Select the [YES] and touch the RTN button.

### <Normal condition mixing curve>

The mixing curve rate should be started using smaller values.

For a rotor with a clockwise operation direction, when pitch was input at the plus side, set these parameters so that mixing is in the clockwise direction. First, trim at hovering and then adjust the neutral position.

#### 1. Adjustment between slow and hovering

Repeatedly hover from take off and land at a constant rate matched to your own rhythm. Then adjust the pitch so that the nose of the helicopter remains steady when the throttle is raised and lowered.

#### 2. Throttle high side (climbing and diving from hovering)

Repeat climbing and diving from hovering at a constant rate matched to your own rhythm and adjust the pitch so that the nose does not deflect when the throttle is raised and lowered.

### <Idle up condition mixing curve>

Set the mixing rate so that the rudder direction at high-speed flight is straight ahead. Adjust for each condition used.

# GYRO mixing

This function used to adjust gyro sensitivity. The sensitivity and operation mode (Normal mode/AVCS mode) can be set for each condition.

The gyro sensitivity can be switched with each condition or the switch. (5 sensitivities)

\*Compatible with 3 axis gyro(CGY750).

**Note:** When using the [Gyro2]/[Gyro3] function, assign [Gyro2]/[Gyro3] to any channel on the function screen.

Always set to [--] both (Control) and (Trim) for the [Gyro] function at the Function menu in the Linkage menu.

- Select [GYRO] at the Model menu and access the setup screen shown below by touching the RTN button.

- Select the function name and return to the Model menu by touching the RTN button. Or the HOME/EXIT button is pushed.

|             |                 |
|-------------|-----------------|
| <b>GYRO</b> | <b>ACTIVE#1</b> |
| EDIT NORMAL | # 1             |
| GY RUD AVCS | 80% < 80%       |
| GY2AIL AVCS | 50% < 50%       |
| GY3ELE AVCS | 50% < 50%       |

<SensorTouch™>

- Scrolling
- Moving cursor
- Selecting mode
- Adjusting value

• To next page

- The edit conditions can be changed by touching the S1 button.

\*When the rate switching setting of all the gyros is "Switch", the edit conditions are not displayed.

- The edit rate can be changed by operating the edit rate button.

\*When the rate switching setting of all the gyros is "COND", the edit rate button is not displayed.

- When the GYRO function button is selected, each GYRO detailed setting screen appears.

- Setup screen selection
- Condition/Switch selection

|             |               |
|-------------|---------------|
| <b>GYRO</b> | <b>NORMAL</b> |
| CONDITION   | NORMAL ON     |
| TYPE GY     | AVCS          |
| RATE        | 80% < 80%     |
| FINE TUNING | -- +0% ( +0%) |

- ON: (initial setting)
- Mode selection: [AVCS]/[NORM]
- Fine tuning VR settings
- Gyro sensitivity adjustment

## Setting method

### ●Gyro type selection

Move the cursor to the gyro type selection item and touch the RTN button to switch to the data input mode. Select the gyro type by scrolling the touch sensor.

[GY]: When a Futaba GY gyro is used

[NORM]: When other than Futaba GY gyro is used

Touch the RTN button to change the gyro type and return to the cursor mode.

\*When a Futaba GY gyro is used and [GY] type is selected, the sensitivity set value is directly read in both the AVCS and NORM modes.

### ●Operation mode selection (GY gyro)

Move the cursor to the operation mode selection item and touch the RTN button to switch to the data input mode. Select the operation mode by scrolling the touch sensor.

[AVCS]: AVCS mode

[NORM]: Normal mode

Touch the RTN button to change the operation mode and return to the cursor mode.

### ●Sensitivity setting

Move the cursor to the rate item and touch the RTN button to switch to the data input mode.

Adjust the sensitivity by scrolling the touch sensor.

Initial value: 80%

Adjustment range: 0~100%

\*When the RTN button is touched for one second, the sensitivity is reset to the initial value.)

Touch the RTN button to return to the cursor mode.

### ●Fine tuning VR settings

Move the cursor to the [--] item and touch the RTN button to access the selection screen. Select the control.

\*For a description of the switch selection method, see the description at the back of this manual.

Move the cursor to the rate item and touch the RTN button to switch to the data input mode.

Adjust the trim rate by scrolling the touch sensor.

Initial value: 0%

Adjustment range: -20~+20%

\*When the RTN button is touched for one second, the sensitivity is reset to the initial value.)

Touch the RTN button to return to the cursor mode.

## <EXAMPLE>Rudder gyro gain is changed with a switch (SF) irrespective of condition.

Generally, gain is interlocked with condition and changes a rate.

How to change two rates in the same condition here.

1. Select [GYRO] at the Model menu and access the setup screen shown below by touching the RTN button.

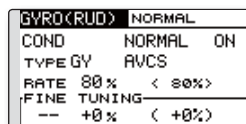

2. Move the cursor to the [COND] item and touch the RTN button to access the selection screen. Select the [SW]. Touch the RTN button to return to the cursor mode.

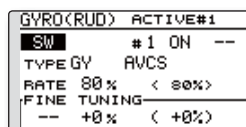

3. # number shows the present switch state. In the state of # 1 a cursor is moved to [--] and RTN is pushed.

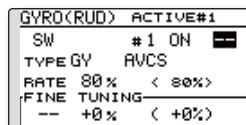

4. [SF] is chosen by [H/W SELECT] and then a top is turned ON.

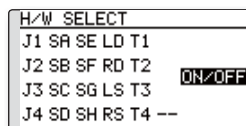

5. [TYPE GY] and [RATE] of a state of "#1=SF top"are set up.



SF : Top = #1

● The number of a SW state

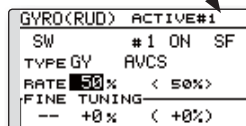

6. It is a setup of "#2". Move the cursor to the [#1] item and touch the RTN button to access the selection screen. Select the [#2]. Touch the RTN button to return to the cursor mode.



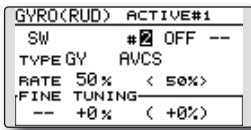

7. Move the cursor to the [--] item and touch the RTN button.
8. [SF] is chosen by [H/W SELECT] and then a bottom is turned ON. the RTN button.
9. [TYPE GY] and [RATE] of a state of "#2=SF bottom"are set up.

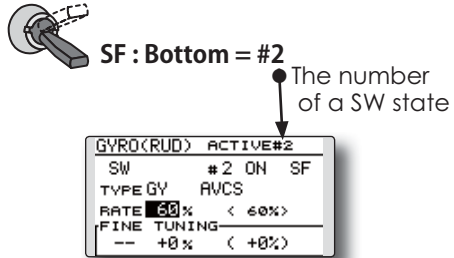

- \*If 3 position switch is chosen, the change of 3 rates can be performed.
- \*Combined use of two or more switches cannot be performed.

# GOVERNOR mixing

When using a Futaba GV-1/GY701/CGY750 governor, this function is used to switch the RPM of the helicopter's rotor head. The rotor head speed can be switched with each condition or the switch.

\*The governor is used by connecting the governor speed setting channel to CH7 (initial setting).

\*When using an independent governor [ON]/[OFF] switch, connect the AUX([ON]/[OFF]) connector of the governor to CH8 and set the switch to CH8 (Governor2) at the Function menu of the Linkage Menu.

**Note: Always set (Control) and (Trim) to [--] for [Governor] of the Function menu of the Linkage menu.**

- Select [GOVERNOR] at the Model menu and access the setup screen shown below by touching the RTN button.
- Setup screen selection
- Condition/Switch selection
- Select the function name and return to the Model menu by touching the RTN button. Or the HOME/EXIT button is pushed.
- Unit display selection: [%]/[rpm]
- RPM adjustment
- Fine tuning VR settings
- ACT/INH: INH (initial setting)
- Scrolling
- Moving cursor
- Selecting mode
- Adjusting value
- To next page

## Setting method

### •Activate the mixing

When using this function, move the cursor to the [INH] item and touch the RTN button to switch to the data input mode. Select the ACT mode by scrolling the touch sensor.

\*The display blinks.

Touch the RTN button to activate the mixing and return to the cursor mode. (ON is displayed.)

When the Governor is changed from the default inhibited (INH) state to the active (ACT) state, the endpoint menu will be displayed and it is possible to utilize the endpoints for this given condition.

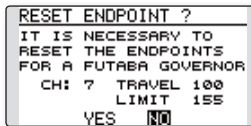

\*When the function is set ON/OFF at the governor setup screen, the governor rpm setting channel end point servo travel and limit point are now initialized.

\*When changed from INH to ACT (ON), the servo travel is initialized to 100 and the limit point is initialized to 155.

\*When operation is changed to INH at all conditions, the servo travel is initialized to 100 and the limit point is initialized to 135.

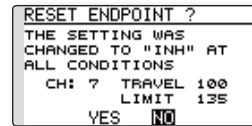

Use the SensorTouch to scroll to either YES (incorporate the default endpoints) or NO (endpoints are not utilized). Press the Return (RTN) button to confirm the selection made.

### •RPM adjustment

Move the cursor to the rate item and touch the RTN button to switch to the data input mode.

Adjust the rpm by scrolling the touch sensor. Initial value: 50% (1500rpm) Adjustment range: OFF, 0~110% (OFF, 700~3500rpm)

\*When the RTN button is touched for one second, the sensitivity is reset to the initial value.)

Touch the RTN button to return to the cursor mode.

### •Unit display selection

Move the cursor to the UNIT item and touch the RTN button to switch to the data input mode. Select the unit by scrolling the touch sensor.

Touch the RTN button to change the operation mode and return to the cursor mode.

## ●Diplay mode selection

\*When [rpm] mode is selected above setting, the display mode can be selected.

\*There is no change in the transmitter output even when the "MODE" is changed. Calibration should be performed via the governor.

\*In order to use the Governor function of the T14SG, it is necessary to change the settings on the governor for the low side 700 rpm mode.

When the MODE of the Governor screen's model menu is changed, the change is also indicated on-screen.



The chart below indicates the mode percentage and the corresponding RPM.

| MODE         | 0%      | 50%     | 100%    | 110%    |
|--------------|---------|---------|---------|---------|
| 1000-2000rpm | 1000rpm | 1500rpm | 2000rpm | 2100rpm |
| 1000-2500rpm | 1000rpm | 1500rpm | 2500rpm | 2700rpm |
| 1000-3500rpm | 1000rpm | 1500rpm | 3500rpm | 3900rpm |
| 700-2000rpm  | 700rpm  | 1500rpm | 2000rpm | 2100rpm |
| 700-2500rpm  | 700rpm  | 1500rpm | 2500rpm | 2700rpm |
| 700-3500rpm  | 700rpm  | 1500rpm | 3500rpm | 3900rpm |

## ●Fine tuning VR settings

Move the cursor to the [--] item and touch the RTN button to access the selection screen. Select the control.

\*For a description of the switch selection method, see the description at the back of this manual.

Move the cursor to the rate item and touch the RTN button to switch to the data input mode.

Adjust the trim rate by scrolling the touch sensor.

Initial value: 0% (0rpm)

Adjustment range: -20~+20% (-200~+200rpm)

\*When the RTN button is touched for one second, the sensitivity is reset to the initial value.)

Touch the RTN button to return to the cursor mode.

## <EXAMPLE>RPM rate is changed with a switch (SF) irrespective of condition.

Generally, RPM rate is interlocked with condition and changes a rate.

How to change two rates in the same condition here.

1. Select [GOVERNOR] at the Model menu and access the setup screen shown below by touching the RTN button.

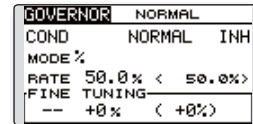

2. Move the cursor to the [COND] item and touch the RTN button to access the selection screen. Select the [SW]. Touch the RTN button to return to the cursor mode. And [INH] is set to [ACT].

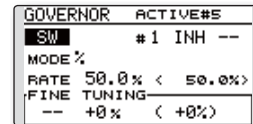

3. # number shows the present switch state. In the state of # 1 a cursor is moved to [--] and RTN is pushed.

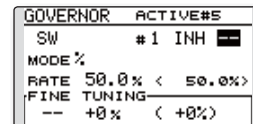

4. [SF] is chosen by [H/W SELECT] and then a top is turned ON.

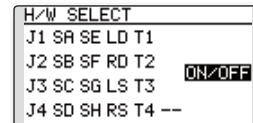

5. [MODE] and [RATE] of a state of "#1=SF top" are set up.

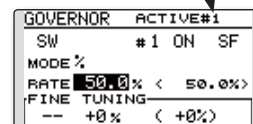
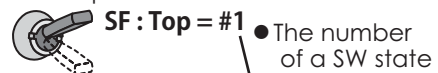

6. It is a setup of "#2". Move the cursor to the [#1] item and touch the RTN button to access the selection screen. Select the [#2]. Touch the RTN button to return to the cursor mode. And [INH] is set to [ACT].

| GOVERNOR    |       | ACTIVE#1 |        |
|-------------|-------|----------|--------|
| SW          | #2    | OFF      | --     |
| MODE %      |       |          |        |
| RATE        | 50.0% | <        | 50.0%> |
| FINE TUNING |       |          |        |
| --          | +0%   | <        | +0%>   |

7. Move the cursor to the [--] item and touch the RTN button.
8. [SF] is chosen by [H/W SELECT] and then a bottom is turned ON. the RTN button.
9. [MODE] and [RATE] of a state of "#2=SF bottom"are set up.



**SF : Bottom = #2**

● The number of a SW state

| GOVERNOR    |       | ACTIVE#2 |        |
|-------------|-------|----------|--------|
| SW          | #2    | ON       | SF     |
| MODE %      |       |          |        |
| RATE        | 60.0% | <        | 60.0%> |
| FINE TUNING |       |          |        |
| --          | +0%   | <        | +0%>   |

\*If 3 position switch is chosen, 3 rate changes can be performed.

\*Combined use of two or more switches cannot be performed.

The Timer function may be set for any desired time, i.e. engine run time, specified times for competitions, etc. Two independent timers are provided for your use. The timers are stored independently with each model, meaning that when you switch between model setups, the timer associated with the new model is brought up automatically.

The timers may be set to start and stop from the motion of any switch or stick. You may set the ON and OFF directions freely. Each timer has a capacity of up to 59 minutes 59 seconds.

Each timer may be set for count-down (DOWN mode) or count up (UP mode) operation with a target time or for count up to 99 hours 59 minutes (HOUR mode).

If a target time is set and the timer reaches the set time, a buzzer sound for each count is generated.

Countdown timers sound one short beep during the last twenty seconds and two short beeps during the last ten seconds before reaching the target, then

a long tone at the target time, and continue counting with displaying a minus (-) sign. Count-up timers also beep the last twenty and ten seconds, beep the target time, and keep counting upwards until shut down.

A mode which sounds an alarm each minute of the time remaining up to the timer alarm time can be selected.

The HOUR mode is convenient when used in engine maintenance period and other long-term measurements.

\*When the HOUR mode is set, "xx (hour): xx (minute)" is displayed on the count time display. Seconds are not displayed.

\*When the HOUR mode is set, ":" blinks each second during timer operation.

\*When the HOUR mode is set, the alarm function is inhibited.

- Select ST1 or ST2 at the home screen and call the setup screen shown below by touching the RTN button.

- Select the function name and return to the home screen by touching the RTN button. Or a HOME/EXIT button is pushed.

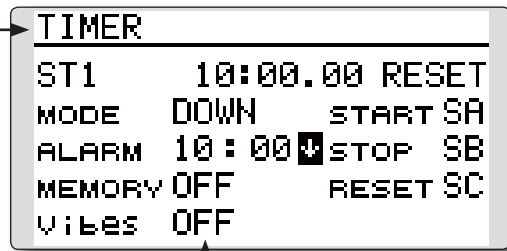

<SensorTouch™>

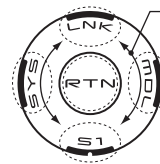

- Scrolling
- Moving cursor
- Selecting mode
- Adjusting value

### "Vibes" type

If the following types are selected, the transmitter will vibrate during the warning.

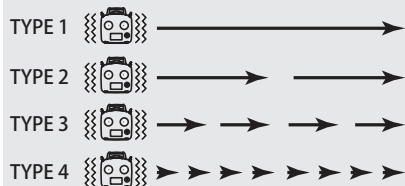

---

## Timer setting

---

### ●Up timer/down timer setting

Move the cursor to the [MODE] item and touch the RTN button to switch to the data input mode.

Select the mode by scrolling the touch sensor and touch the RTN button.

[UP]: Up timer

[DOWN]: Down timer

[HOUR]: Hour mode timer

### ●Timer time setting

Move the cursor to the [ALARM] item and touch the RTN button to switch to the data input mode.

Set the time by scrolling the touch sensor.

[00]:[00]:[min]:[sec]

Touch the RTN button to end the adjustment and return to the cursor mode.

### ●Switch setting

Move the cursor to the item of the switch you want to set, access the switch setup screen by touching the RTN button. Select the switch and ON direction.

[For a detailed description of the setting method, see [Switch Setting Method] located on the next page.]

[START]: Start switch

[STOP]: Stop switch

[RESET]: Reset switch

### ●Memory setting

Move the cursor to the [MEMORY] item and touch the RTN button to switch to the data input mode.

Select the mode by scrolling the touch sensor and touch the RTN button.

[OFF]: Memory function OFF

[ON]: Mode where the timer is not reset when turned power off and switched the model.

### ●A mode which sounds an alarm each minute can be selected.

Change the setting using the "↑" button (or "↓" button).

"↑": Alarm sounds each minute of the time elapsed from timer start. (Conventional mode)

"↓": Alarm sounds each minute of the time remaining up to the alarm time.

## Timer operation

---

- Timer ST1 and ST2 are started/stopped by pre-selected start/stop switch.
- To reset a timer, operate the pre-selected reset switch, or move the cursor to the [RESET] display on the timer screen and touch the RTN button.

## Switch Setting Method

The various functions used in the T14SG can be activated by a switch. For the purposes of this manual, a stick position, VR position, etc. shall be commonly referred to as a switch in all cases. That

is, whenever the manual indicates that something is operated via a switch, it is possible for the user to activate this setting via a stick, stick position, etc.

### Switch selection

When a switch is selected at a mixing function, etc., the selection screen shown below is called.

(Switch selection screen example)

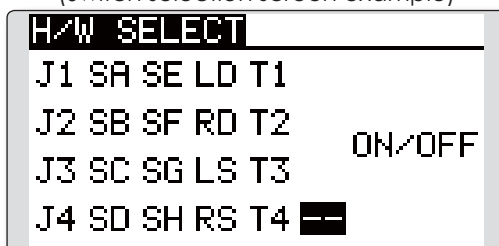

#### Switch selection

1. Use the touch sensor to move the cursor (highlights) to the switch you want to select and touch the RTN button.

\*The switch blinks.

2. To return to the preceding screen, move the cursor to the [H/W SELECT] at the top of the screen and touch the RTN button.

Or, move the cursor to the [ON/OFF] and call the ON/OFF position setting screen by touching the RTN button.

#### When stick, trim lever, or knob selected

When a stick, trim lever, or knob is used as a switch, two operation modes can be selected:

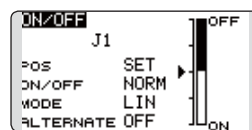

1. When you want to change the mode, move the cursor to [MODE] item and touch the RTN button to switch to the data input mode. Switch the display to the mode you want to change by scrolling the touch sensor and then make the change by touching the RTN button.

●Mode: [LIN]/[SYM]

\*Set the ON/Off point by the method described on the next page.

#### When switch is selected

When switch was selected, ON/OFF position setting is also performed.

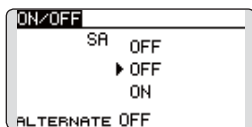

\*The ON/OFF setting state of each position is displayed.

1. When you want to change the ON/OFF setting, use the touch sensor to move the cursor and touch the RTN button to switch to the data input mode. Switch the ON/Off display by scrolling the touch sensor.

\*ON/OFF display blinks.

2. When the RTN button is touched, the ON/Off setting is changed. (Touch the S1 button to stop the change.)
3. To return to the preceding screen, move the cursor to the [ON/OFF] at the top of the screen and touch the RTN button.

#### Alternate mode setting

●ALTERNATE mode: [OFF]/[ON]

1. Move the cursor to the [ALTERNATE] item and touch the RTN button to switch to the data input mode.
  2. Change to the mode you want to set by scrolling the touch sensor.
- \*The mode display blinks.
3. Touch the RTN button. (Touch the S1 button to stop the change.)
  4. To return to the preceding screen, move the cursor to the [ON/OFF] at the top of the screen and touch the RTN button.

---

## Operation modes

The operation modes available when stick, trim lever, or knob was selected are described below.

### Linear mode [LIN]

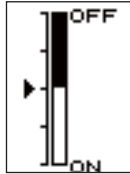

This mode sets ON/OFF to the left or right (up or down) with the set point as the reference.

### Symmetrical mode [SYM]

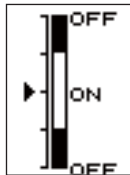

Left and right (up and down) operations are symmetrical near the neutral position. For instance, when you want to switch D/R with the aileron stick, when the stick is moved to the left or right, DR can be turned on at the same position.

### Shifting the ON/Off point

The ON/OFF point can be shifted. ON/OFF at a free position can be changed.

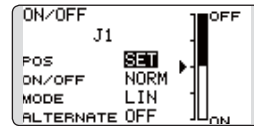

- Black range: OFF range
- White range: ON range

#### [Setting method]

1. First, use the touch sensor to move the cursor to the [POS] item.
2. Move the stick, trim lever, or knob to the point you want to change and touch the RTN button. The point is shifted.
3. To return to the preceding screen, move the cursor to the [ON/OFF] at the top of the screen and touch the RTN button.



---

## Logic switch (Condition Select function only)

---

The logic switch function lets you turn operation on and off by combining two switches.

### Logic mode

AND: When both switches are ON, the condition is ON.

OR: When either switch is ON, the condition is ON.

EX-OR: When the two switches are in different states, the condition is ON.

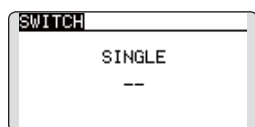

### Switch mode selection

1. Move the cursor to the [SINGLE] item and touch the RTN button to switch to the data input mode.
2. Select the [LOGIC] by scrolling the touch sensor.  
\*[LOGIC] display blinks.
3. Touch the RTN button to change to the logic switch mode.

(Logic switch setting screen)

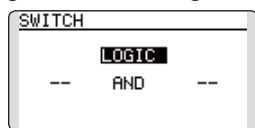

### Logic mode selection

1. Move the cursor to the logic mode item and touch the RTN button to switch to the data input mode.
2. Select the logic mode by scrolling the touch sensor. [AND, OR or EX-OR]  
\*The mode display blinks.
3. Touch the RTN button to change to the logic mode.

### Swich selection

1. Select the right and left switch respectively.  
(Refer to the description at the previous page.)

To return to the preceeding screen, move the cursor to the [SWITCH] at the top of the screen and touch the RTN button.